



Version 03

USER'S MANUAL PARTS BOOK

FORTUNA

AC Servo Motor series IV

ISO 9001 Certification of Quality System

- 1) FOR AT MOST USE WITH EASINESS.
PLEASE CERTAINLY READ THIS MANUAL
BEFORE STARTING USE
- 2) KEEP THIS MANUAL IN SAFE PLACE
FOR REFERENCE WHEN THE MACHINE
BREAKS DOWN.

SunStar CO., LTD.

MEE-090929

From the library of: Superior Sewing Machine & Supply LLC



1. Thank you for purchasing our product. Based on the rich expertise and experience accumulated in industrial sewing machine production, SUNSTAR will manufacture industrial sewing machines, which deliver more diverse functions, high performance, powerful operation, enhanced durability, and more sophisticated design to meet a number of user's needs.
2. Please read this user's manual thoroughly before using the machine. Make sure to properly use the machine to enjoy its full performance.
3. The specifications of the machine are subject to change, aimed to enhance product performance, without prior notice.
4. This product is designed, manufactured, and sold as an industrial sewing machine. It should not be used for other than industrial purpose.

MANUAL CODE NO.
SIVK001-04



USER'S MANUAL

CONTENTS

1. SAFETY INSTRUCTION	8
2. PRECAUTIONS BEFORE USE	10
3. LOCATING AND USING PARTS OF THE CONTROLLER BOX	12
4. INSTALLATION	14
1) Attaching controller to table	14
2) Attaching pedal unit	14
3) Installing and adjusting knee lifter solenoid	15
4) Needle Bar Up/Down Stop Position Setting	15
5) Installing program unit	18
6) SunStar machine installed with program unit	18
5. WIRING AND GROUNDING	19
1) Specification of the power plug	19
2) Specification of electric current in wiring of power plug	19
3) Names and Explanation of external connector in control box	20
4) Changing solenoid supply voltage (Basic setting values upon shipment: J19)	20
6. CONNECTION THE EARTH WIRE OF THE SEWING MACHINE AND MOTOR	22
7. THINGS TO BE CHECKED AFTER INSTALLATION	22
8. PROGRAM UNIT PART NAMES AND METHOD OF USE	23
1) Program unit part names	23
2) Program Unit Method of Use	23
3) Start and End Backtack Stitch Correction Method	34
4) Method of Use: Inertia Tuning Function	37
5) Sewing machine head open error and safety switch error	37
6) How to Use Edge Sensor	38
7) Motor Controller Setting	41
8) Use of KM-360J	45
9) Use of Detailed TPM(Total Production Maintenance) Functions.....	46
9. SIMPLE OPERATION UNIT PART NAMES AND METHOD OF USE	49
1) Names of Each Part in the Simple Operation Unit	49
2) Simple Program Unit Method of Use	49
10. FORTUNA SERIES 4 FULL FUNCTION SOFTWARE METHOD OF USE	54
1) Basic Functions of the Fortuna Series 4 Full Function Software	54
2) Fortuna Series 4 Full Function Software Specific Parameters	55
3) Method of Use and Explanations for Specific Items of the Parameter	69
4) Thread Trimming Sequence Function Method of Use (Items no. 54, 55, 56 of Group B)	73
11. BREAKDOWN AND TROUBLESHOOTING	82

12. HOW TO PLACE FOR CONTROLLER	83
13. BLOCK DIAGRAM	84
※ Fortuna IV 750W USER'S MANUAL	85
(What is not specified here can be found in "User Manual for Fortuna Series 4".)	
1. PRECAUTIONS BEFORE USE	86
2. LOCATING AND USING PARTS OF THE CONTROLLER BOX	88
3. INSTALLATION	90
1) Mounting your Servo Motor on the table	90
2) Assembling the belt cover and adjusting the belt tension.....	91
3) Attaching controller to table	92
4) Attaching pedal unit	92
5) Installation of full function program unit.....	93
6) Small-type Program Unit Installation Method	94
7) SunStar machine installed with program unit.....	94
8) Mounting and adjusting the foot-lift solenoid.....	95
9) Mounting the position sensor (Synchronizer) and setting the film.....	96
10) How to equip and adjust a built-in location detector(synchronizer).....	98
4. WIRING AND GROUNDING.....	100
1) Specification of the power plug.....	100
2) Specification of electric current in wiring of power plug	100
3) Names and Explanation of external connector in control box	101
4) Changing solenoid supply voltage (Basic setting values upon shipment: J19)	102
5. CONNECTION THE EARTH WIRE OF THE SEWING MACHINE AND MOTOR	103
6. THINGS TO BE CHECKED AFTER INSTALLATION	103
7. PARTS NAME AND USE OF SMALL-TYPE PROGRAM OPERATING PANEL	104
1) Parts Name of Small-type Program Operating Panel	104
2) Use of Small-type Program Operating Panel	105
3) Use method of product counter and bobbin counter.....	110
4) Using Method of the Short Thread Trimmer Type	114
5) Initial and Close Backtack Accuracy Function Correction Method	116
6) Small-type Program Operating Panel Functions Same as Full Function Program Operating Panel	117
8. Fortuna Series 4 750[W] Full Function Software Method of Use	118
1) Basic Functions of the Fortuna Series 4 750[W] Full Function Software	118
2) Fortuna Series 4 750[W] Full Function Software Specific Parameters	119
※ PARTS BOOK	134

1

SAFETY INSTRUCTION

Be sure to read and keep in mind the following instructions before you install and use the FORTUNA SERVO MOTOR.

1) Use and Purpose

This product is designed, manufactured, and sold as an industrial sewing machine. It should not be used for other than industrial purpose.

2) Working Environment

① Power Source

- It is desirable that voltage of the power source be kept within the range of 10% of the rated voltage.
- It is desirable that frequency of the power source be kept within the range of 10% of the rated frequency. (50/60Hz)
- The SERVO MOTOR can be expected to work normally only in case the foregoing things are kept.

② Electromagnetic Noise

- It is desirable that those equipments causing strong electromagnetic field or high frequency not use the same electrical outlet as this on and stay away from it.

③ Temperature and Humidity

- Keep the ambient temperature above 5 degrees and below 40 degrees Centigrade.
- Never use it outdoors and avoid direct ray of light.
- Keep it away from an hot object like a stove.
- Keep the ambient humidity above 30% and below 95%.

④ Never use it near gases and explosives.

⑤ Do not use it at a spot located 1,000m or higher above sea-level.

⑥ Keep the storage temperature higher than 25 degrees below zero and lower than 55 degrees Centigrade when not in use.

3) Installation

Follow the instruction carefully when installing it.

① Be sure to start installing it after pulling the power plug off the outlet.

② Fix the cable so that it may not move, and do not allow the moving parts like belts to be interfered with. (Keep distance of at least 25mm from them.)

③ Be sure to have the Controller and the sewing Machine grounded.

④ Be sure that the voltage of power source fits the specification of the Controller before the power is on.

⑤ Be sure to use Safety Extra Low Voltage when an extra item or an accessory is fitted into the Controller.

4) Disassembly

① Indissembling it, be sure to wait at least 360 seconds before taking any action after pulling the plug off the power source after turning it off.

② When pulling off the plug from the power source, be sure to hold the plug itself instead of the wire connected to the plug.

5) Service and Maintenance

- ① Make sure that service and maintenance are carried out by a skilled technician.
- ② Never try to operate with the Motor and the Controller open.
- ③ When inserting a thread into or touching the machine, be sure to turn the power off and step down from the platform.
- ④ Be sure to use standard products specified for replacement of parts.

6) Other Safety Instructions

- ① Take care not to let your fingers touch any moving parts including belts.
- ② In case of remodelling or fitting of additional device, be sure to follow safety standards and do not ever try to go ahead based on your own judgments.
- ③ Do not try to operate with the safety device removed.
- ④ Take care not to let water or coffee or something like those admitted into the Controller or the Motor.
- ⑤ Never drop the Controller or the Motor to the ground.

※The instructions presented above are for the safer and more proper operation of the Fortuna Servo Motor. Ignoring such instructions could cause damage to the machine or physical injury of the user. Please follow all the instructions when operating the machine.

2

PRECAUTIONS BEFORE USE

1. Do not turn on the power while stepping on the pedal.

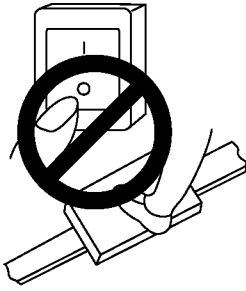

2. Turn off the power when leaving the servomotor overnight.

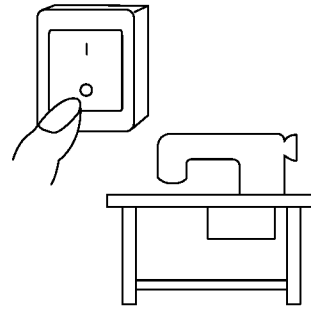

3. Turn off the power when servicing the servomotor or changing the needle.

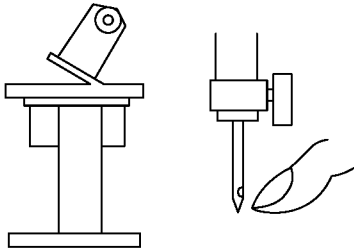

4. Be sure to keep the servomotor securely grounded.

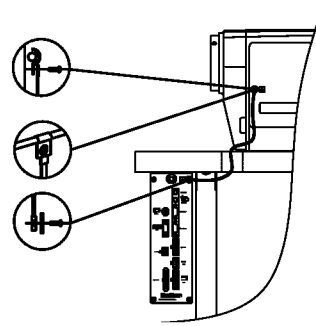

5. Do not connect multiple servomotor power plugs to the same power strip.

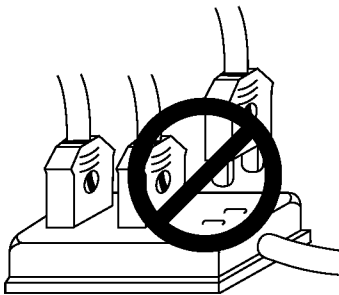

6. Install the servomotor away from noise sources, such as high-frequency equipments and welding machines.

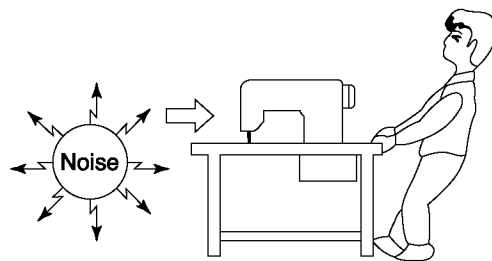

7. Avoid electrical shock when servicing the controller box. (Wait for 6 minutes before opening the cover after turning off the power.)

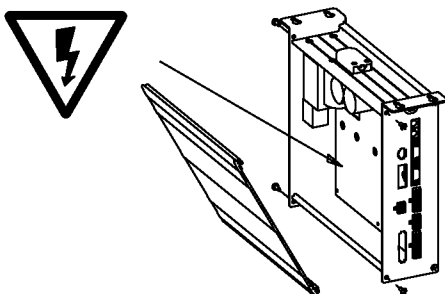

8. When an error message "Er" appears on the digital display, take a note of the "Er" code, and then turn on and off before resuming operation (Contact the local dealer if "Er" message persists on the display)

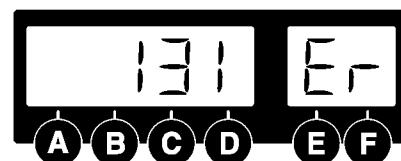

9. Clean it every two or three weeks so that no dirt or a dirty substance may be piled up.

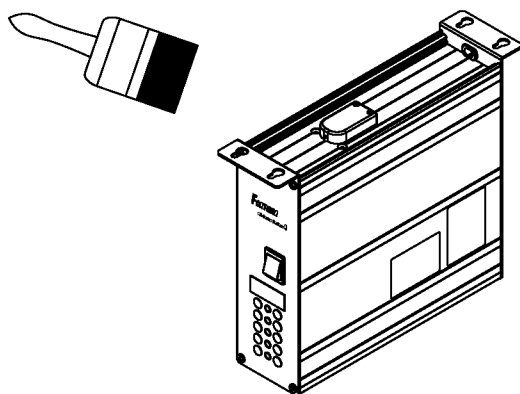

10. When replacing the fuse, use a standard item, opening the cover as shown in the diagram.

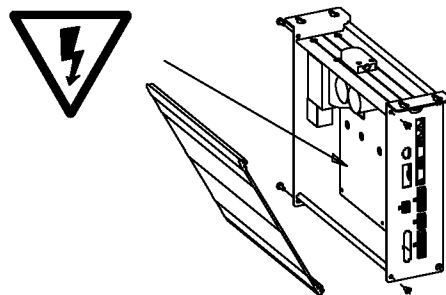

F1	250V/15A [65TL/31.8mm]
F2	250V/15A [65TL/31.8mm]
F3	250V/1A [50T/20mm]
F4	250V/6.3A [50T/20mm]

11. Make the length of the cable connected with an outside parts like stand-up pedal as short as possible.

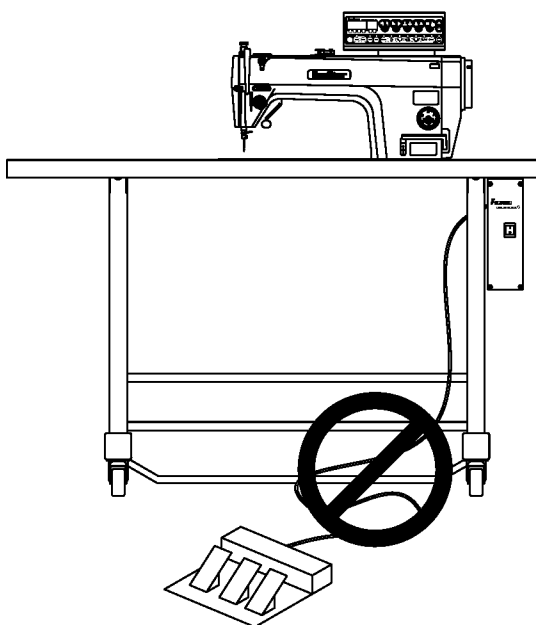

3

LOCATING AND USING PARTS OF THE CONTROLLER BOX

1) Front and back of control box

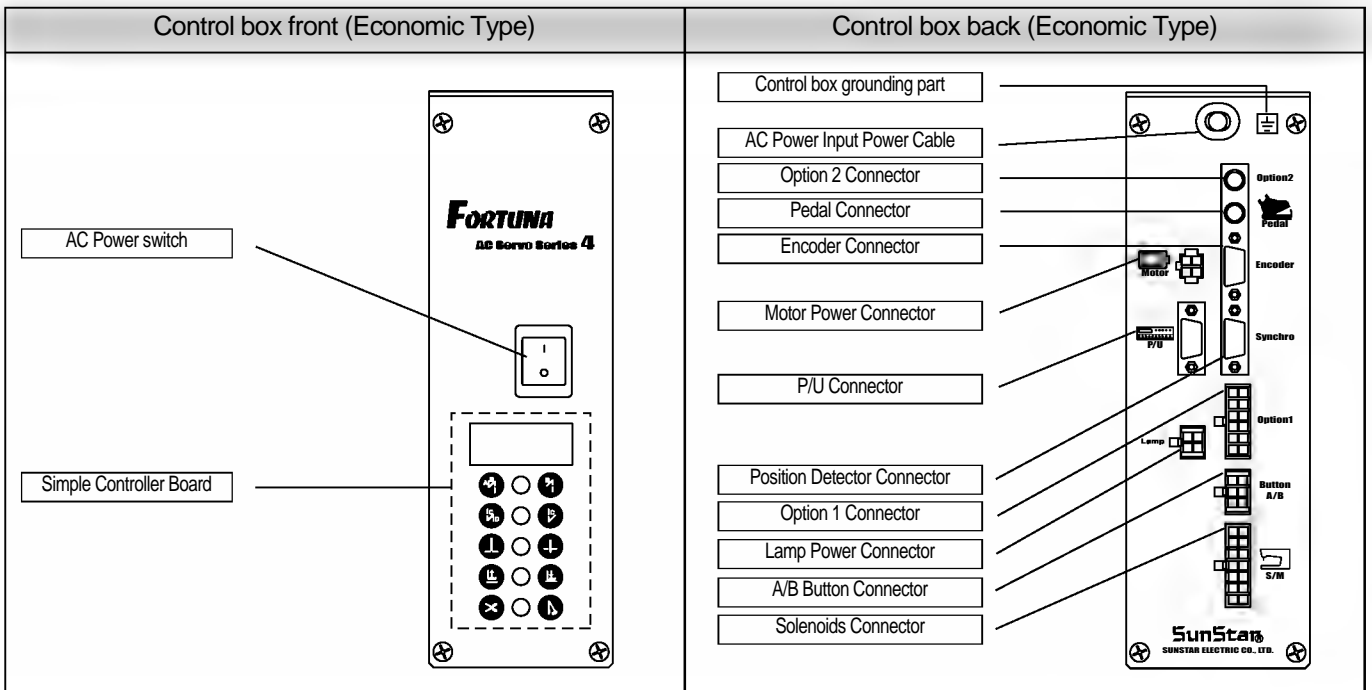
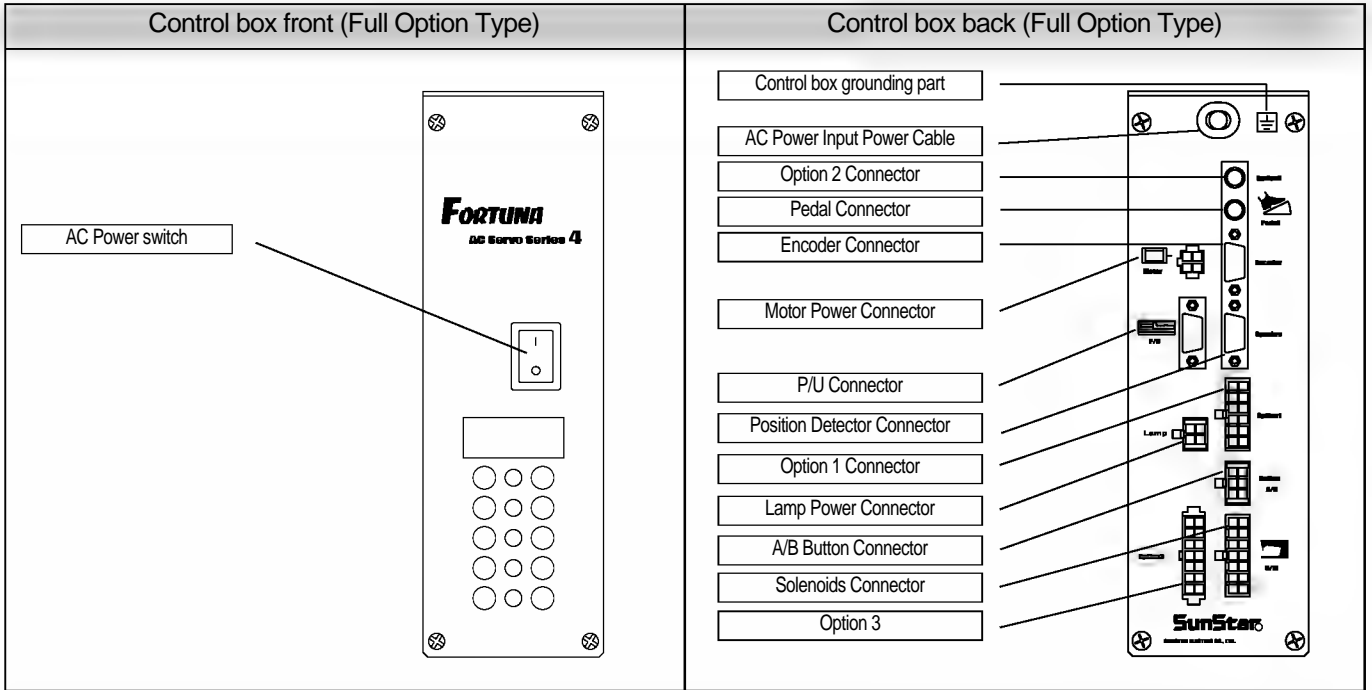

2) Control box side

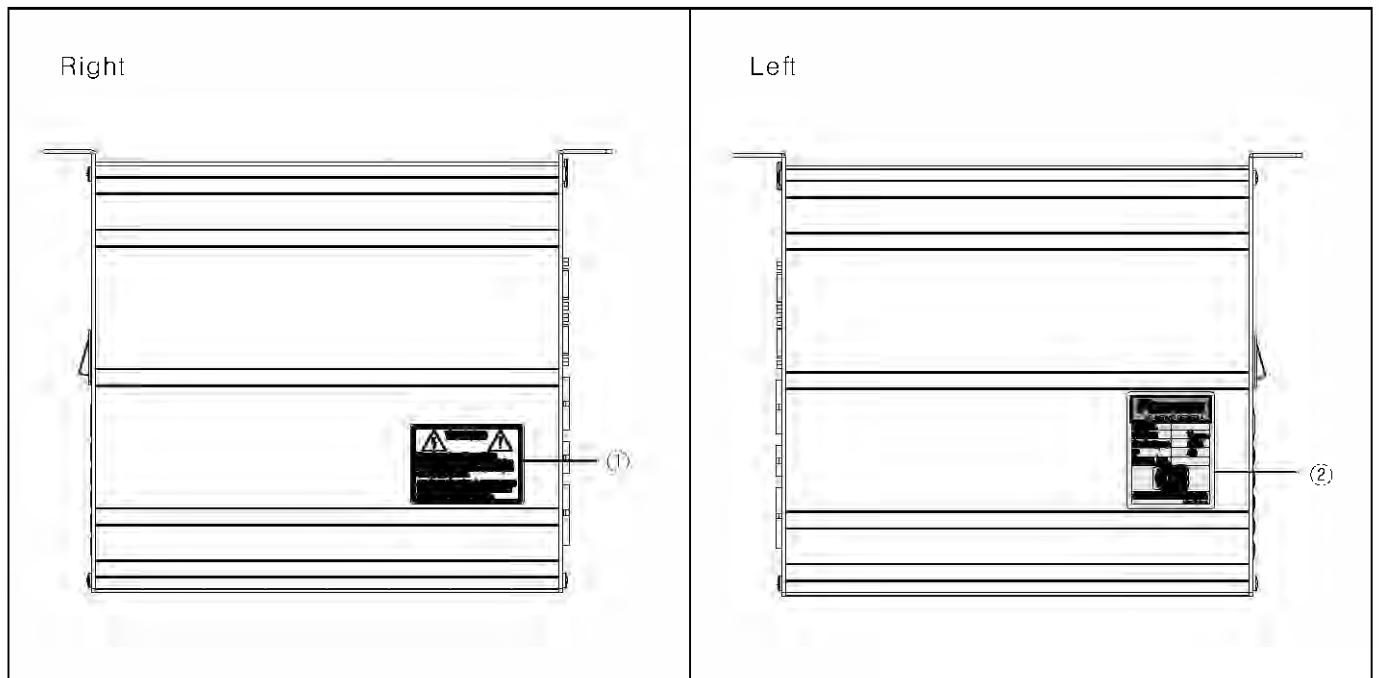

① Caution

WARNING
경고

Hazardous voltage will cause injury.
Be sure to wait at least 360 seconds before opening this cover after turn off main switch and unplug power cord.

고압 전류에 의해 감전될 수 있으므로 커버를 열 때는 전원을 내리고 전원 플러그를 뽑고 나서 360초간 기다린 후 여십시오.

② Specification

FORTUNA
AC SERVO SERIES 4

MODEL	
POWER	V _{50/60Hz}
Current(MAX)	5.0A
IP	40
SERIAL NO.	

SUNSTAR ELECTRIC CO., LTD.
MADE IN KOREA

4

INSTALLATION

1) Attaching controller to table

- ① As in the figure, attach control box to the lower right of the table with 15mm fixing screws.

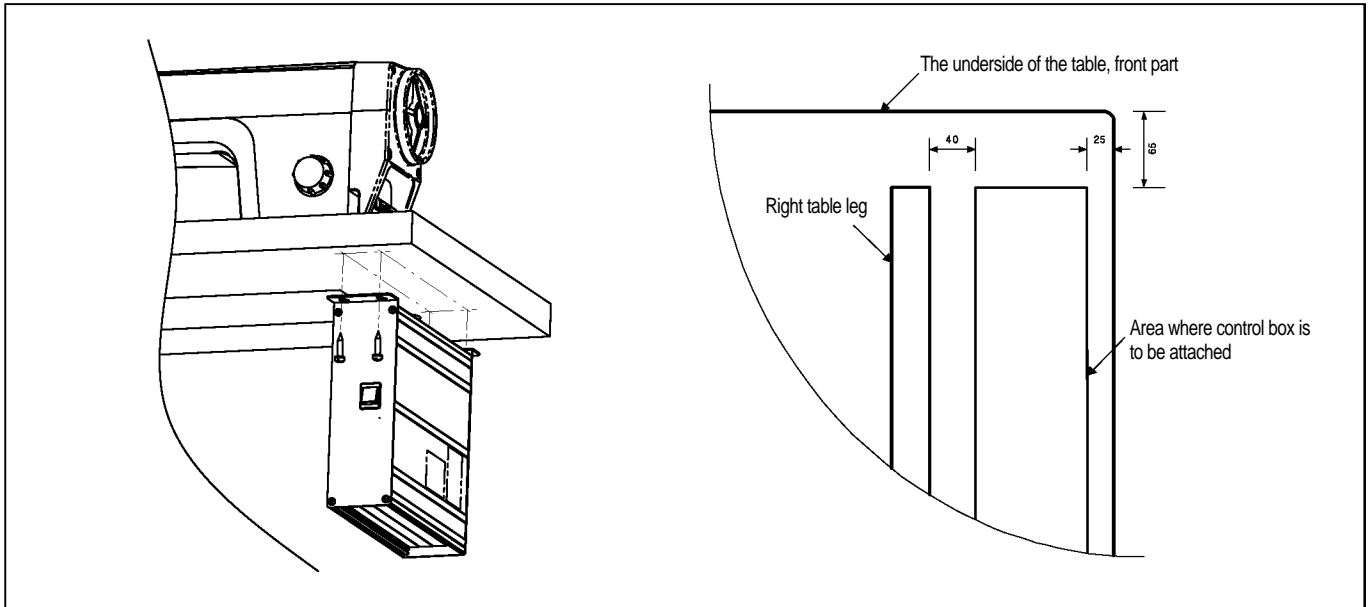

2) Attaching pedal unit

- ① As in the figure, attach pedal unit bracket to the underside of table with 15mm fixing screws.

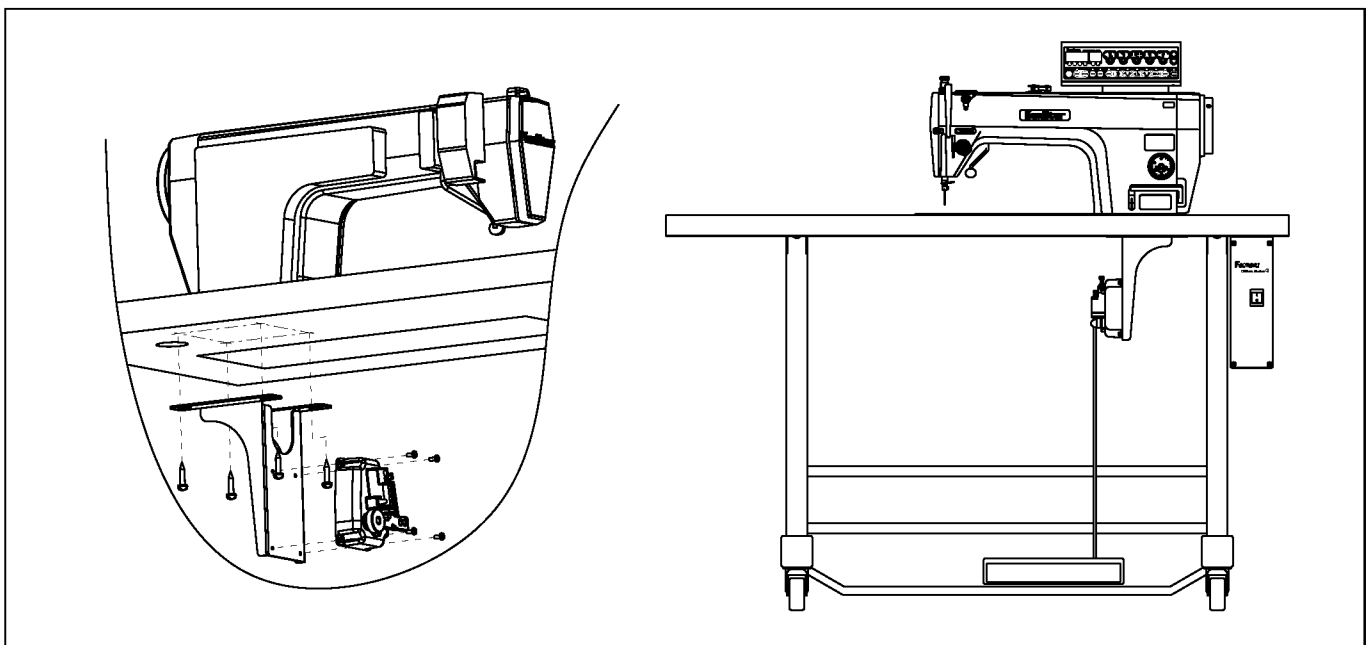

3) Installing and adjusting knee lifter solenoid

(1) For Sunstar KM-2300 Sewing Machine

- ① Assemble Ornamental panel of knee lifter solenoid on the back of KM-2300 body
- ② Attach knee lifter solenoid on bracket A.
- ③ Attach the bracket A fixed on the knee lifter solenoid.
- ④ After attaching crank on the solenoid shaft, connect to the machine.
- ⑤ Put cover over solenoid.
- ⑥ Connect grounding cable.

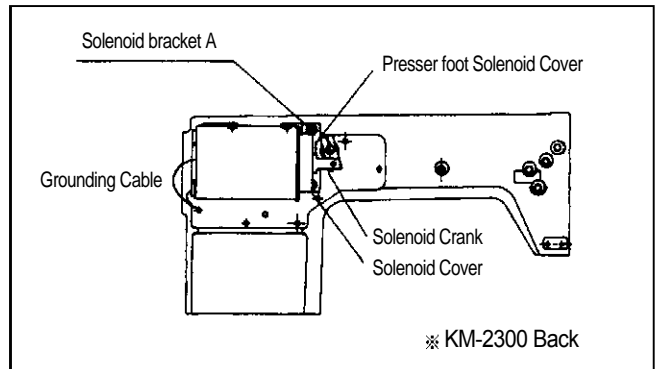

4) Needle Bar Up/Down Stop Position Setting







(1) Installing Position detector (KM-2300Series, SC-7300Series)

- ① Synchronizer is attached on the machine upon shipment.
- ② When changing and fixing synchronizer, see the manual.



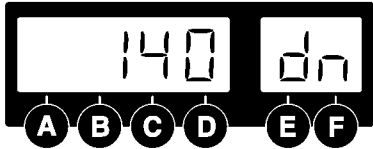
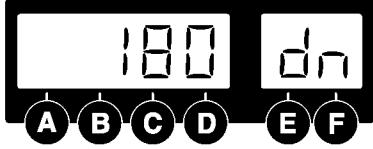

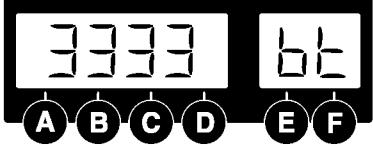
(2) Setting needle bar up-/down- stop position with using program unite (KM-2300Series, SC-7300Series)





- Fortuna Series IV allows a user set up-down stop position by using program unite without changing setting of synchronizer.
- ① Setting needle bar up-down stop with using optional program unite.

<p>① Turn on the down-stop icon lamp by pressing needle bar up-/down-stop button on the program unit to set needle bar down-stop position.</p>	
<p>② When the up stop lamp on, press needle bar up-down stop button with pressing the button. After that, as in the figure letter showing information on the setting target and number pointing the current position will blink.</p>	
<p>③ Turn the pulley forward manually to move the needle bar to the desired position. The screen displays changing position of needle bar.</p>	
<p>④ When the needle bar moves to the desired position, save the position by pressing key. Then, the screen automatically returns to the initial screen with a buzzer.</p>	
<p>[Caution] Returning to the initial screen by pressing button without pressing button will not save reset values.</p>	

<p>⑤ Furthermore, turn on the down-stop icon lamp by pressing needle bar up-/down-stop button on the program unit to set needle bar down-stop position.</p>	
<p>⑥ When the down-stop lamp turns on, press  button while pressing needle bar up-/down-stop button.  Then, as in the figure right, the information on what is to be set and the numbers that tell the current position of needle bar will be shown.</p>	
<p>⑦ Turn the pulley forward manually to move the needle bar to the desired position. The screen displays changing position of needle bar.</p>	
<p>⑧ When the needle bar moves to the desired position, save the position by pressing  key. Then, the screen automatically returns to the initial screen with a buzzer.</p>	
<p>[Caution] Returning to the initial screen by pressing  button without pressing  button will not save reset values.</p>	

② Setting needle bar up-/down-stop position by using simple controller board (front OP).

<p>① Turn on the up-stop icon lamp by pressing needle bar up-/down-stop button on the simple controller board to set needle bar up-stop position.</p>	
<p>② When the up-stop lamp turns on, press “E” button while pressing needle bar up-/down-stop button (“C”). Then, as in the figure right, the numbers that tell the current position of needle bar will be displayed.</p>	
<p>③ The operator turns the pulley forward manually to move the needle bar to the desired position. The screen displays changing position of needle bar.</p>	
<p>④ When the needle bar moves to the desired position, save the position by pressing “C” key. Then, the screen automatically returns to the initial screen with a buzzer.</p>	
<p>[Caution] Returning to the initial screen by pressing “E” button without pressing “C” button will not save reset values.</p>	

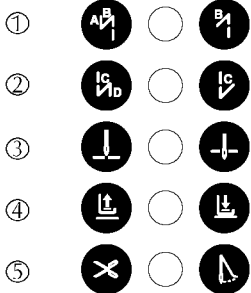
<p>⑤ To set needle bar down stop position, press needle bar up-down stop button of simple controller board to make on the icon lamp of needle bar up stop.</p>	
<p>⑥ When the down stop lamp on, press needle bar up-down stop button “C” with pressing “E” button. After that, number pointing the current needle bar position will blink.</p>	
<p>⑦ Turn the pulley forward manually to move the needle bar to the desired position. The screen displays changing position of needle bar.</p>	
<p>⑧ When the needle bar moves to the desired position, save the position by pressing “C” key. Then, the screen automatically returns to the initial screen with a buzzer.</p>	
<p>[Caution] Returning to the initial screen by pressing “E” button without pressing “C” button will not save reset values.</p>	
<p>[Caution] The names of buttons on simple controller board are as follows. ① A Button switch (Switch for initial Reverse) ② B Button switch (Switch for end reverse) ③ C Button switch (Switch for needle bar up-down stop when the machine stops) ④ D Button switch (Switch for automatic presser foot ascending when the machine stops) ⑤ E Button switch (Switch for program)</p>	

5) Installing program unit

- ① As in the figure below, attach program unit bracket to program unit with three fixing screws. As in the figure, attach the bracket with program unit to the head of machine firmly with two fixing screws.

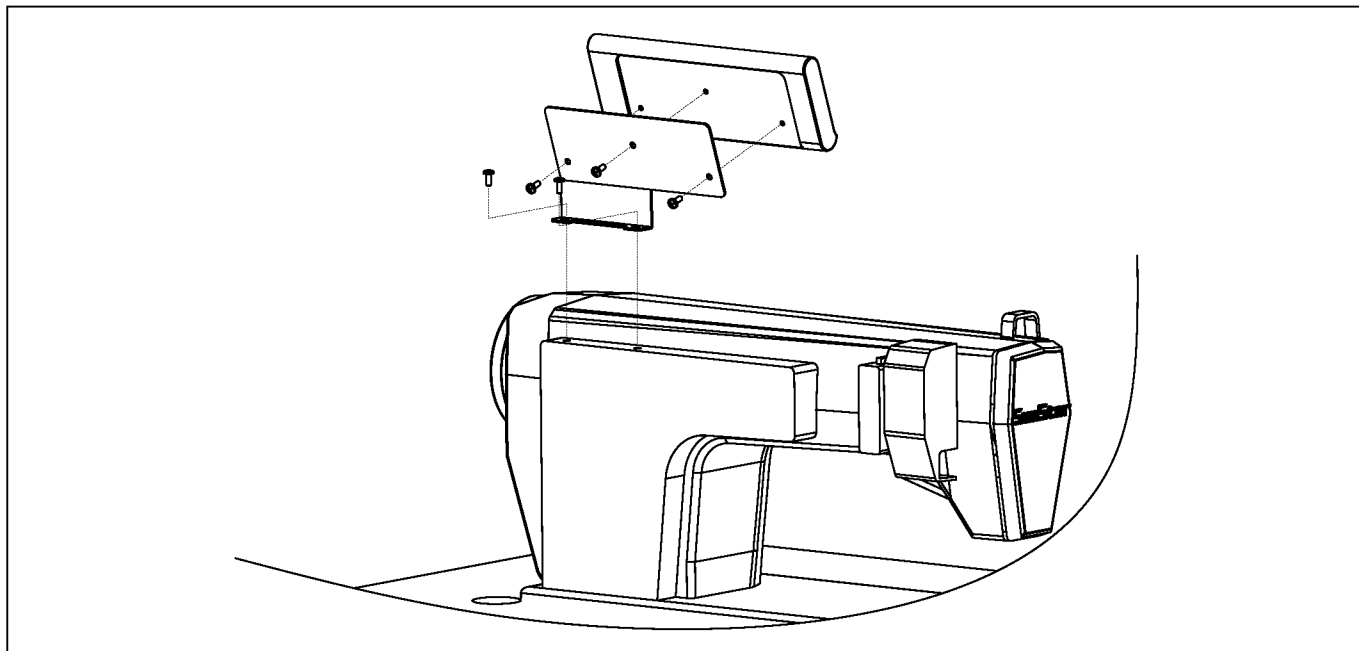

6) SunStar machine installed with program unit

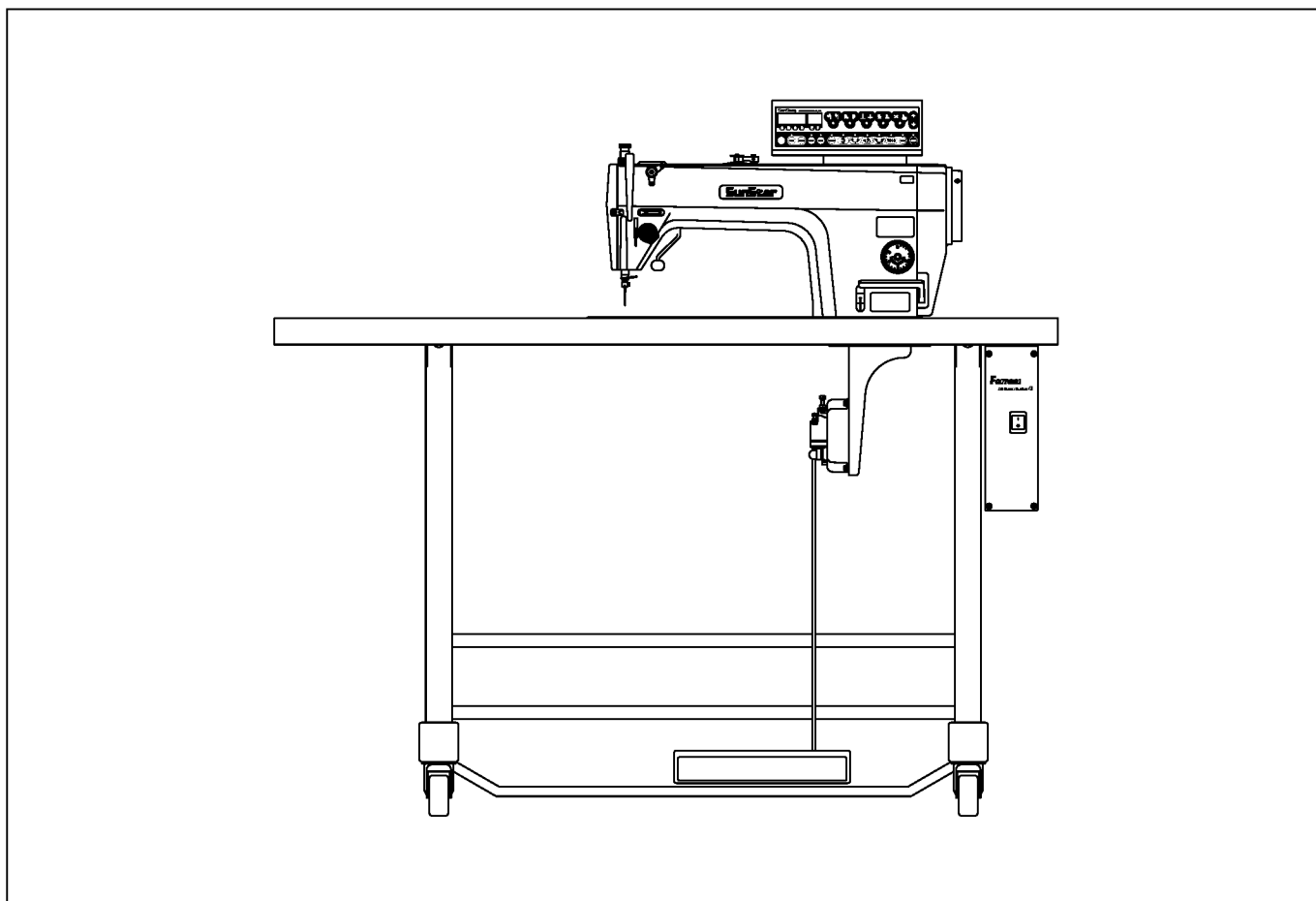

5

WIRING AND GROUNDING

1) Specification of the power plug

(1) Single phase 100V~120V

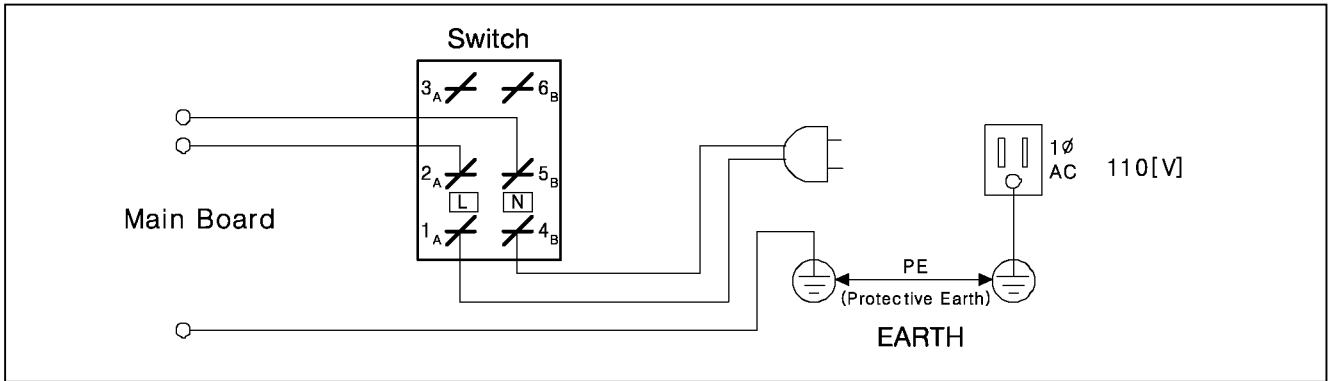

(2) Single phase 200V~240V

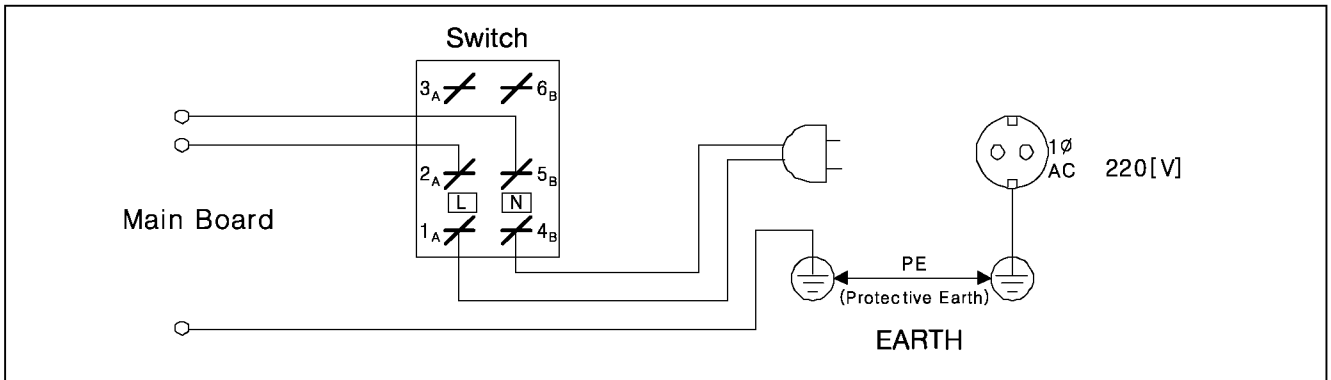

(3) Three phase 200V~240V

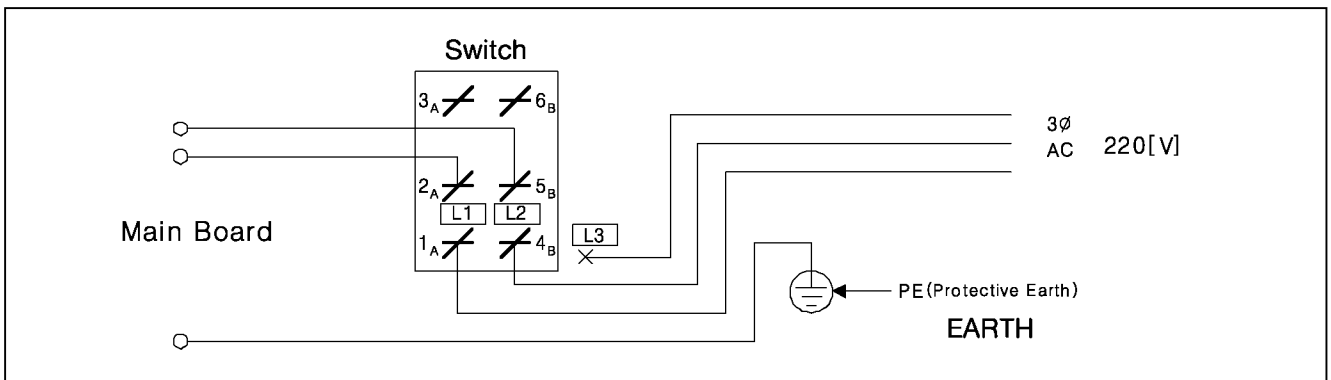

※ Be sure to connect Protective Earth

2) Specification of electric current in wiring of power plug

Be sure to use wiring materials which can stand electric current of higher than 15A.

3) Names and Explanation of external connector in control box

① Solenoid Connector (5566-16P)

[Pin Number]							
16	15	14	13	12	11	10	9
8	7	6	5	4	3	2	1

1, 9: Back Tack solenoid 2,10: knee lifter solenoid 3,11: Trimming solenoid 4,12: Wiper solenoid	5,13: Left needle control solenoid 6,14: Right needle control solenoid 7,15: Thread release solenoid 8,16: Auxiliary solenoid
---	--

② Basic switch connector (5566-8P)

[Pin Number]			
8	7	6	5
4	3	2	1

1,5: Manual Back tack button A 2,6: Back tack Insert/Delete Button B	3,7: Knee lifter solenoid switch 4,8: Safety Switch
---	--

③ Switch and lamp connector (5566-14P)

[Pin Number]						
14	13	12	11	10	9	8
7	6	5	4	3	2	1

1, 2, 7 : GND 3 : Left switch LED 4 : Right switch LED 5 : Left switch 6 : Right switch 8 : VCC (5[V])	9 : 4/4 10 : 3/4 11 : 2/4 12 : 1/4 13 : Switch-HALF 14 : Switch-CNT
---	--

④ Extension connector (5566-20P)

[Pin Number]									
20	19	18	17	16	15	14	13	12	11
10	9	8	7	6	5	4	3	2	1

9, 10 : 12[V] 1~6 : GND 7, 8, 17~20 : VCC (5[V])	11 : Output 12 12 : Output 13 13 : Output 14 14 : Output 15 15 : External Input 00
--	--

4) Changing solenoid supply voltage (Basic setting values upon shipment: J19)

※ It is for a good operation of solenoid when AC input voltage changes.

① Setting values of solenoid supply voltage against input voltage (input voltage 220V series)

Solenoid with the rating current of 30V

Input Voltage	Setting Values
Less than 210V	J20
210V~230V	J19
More than 230V	J18

Solenoid with the rating current of 24V

Input Voltage	Setting Values
Less than 180V	J20
180V~190V	J19
More than 190V	J18

② Setting values of supplied voltage to solenoid against input voltage (Input voltage: 110V)

Solenoid with rating current of 30V

Input Voltage	Setting Values
Less than 100V	J20
100V~120V	J19
More than 120V	J18

Solenoid with rating current of 24V

Input Voltage	Setting Values
Less than 90V	J20
90V~100V	J19
More than 100V	J18

③ Setting supplied voltage

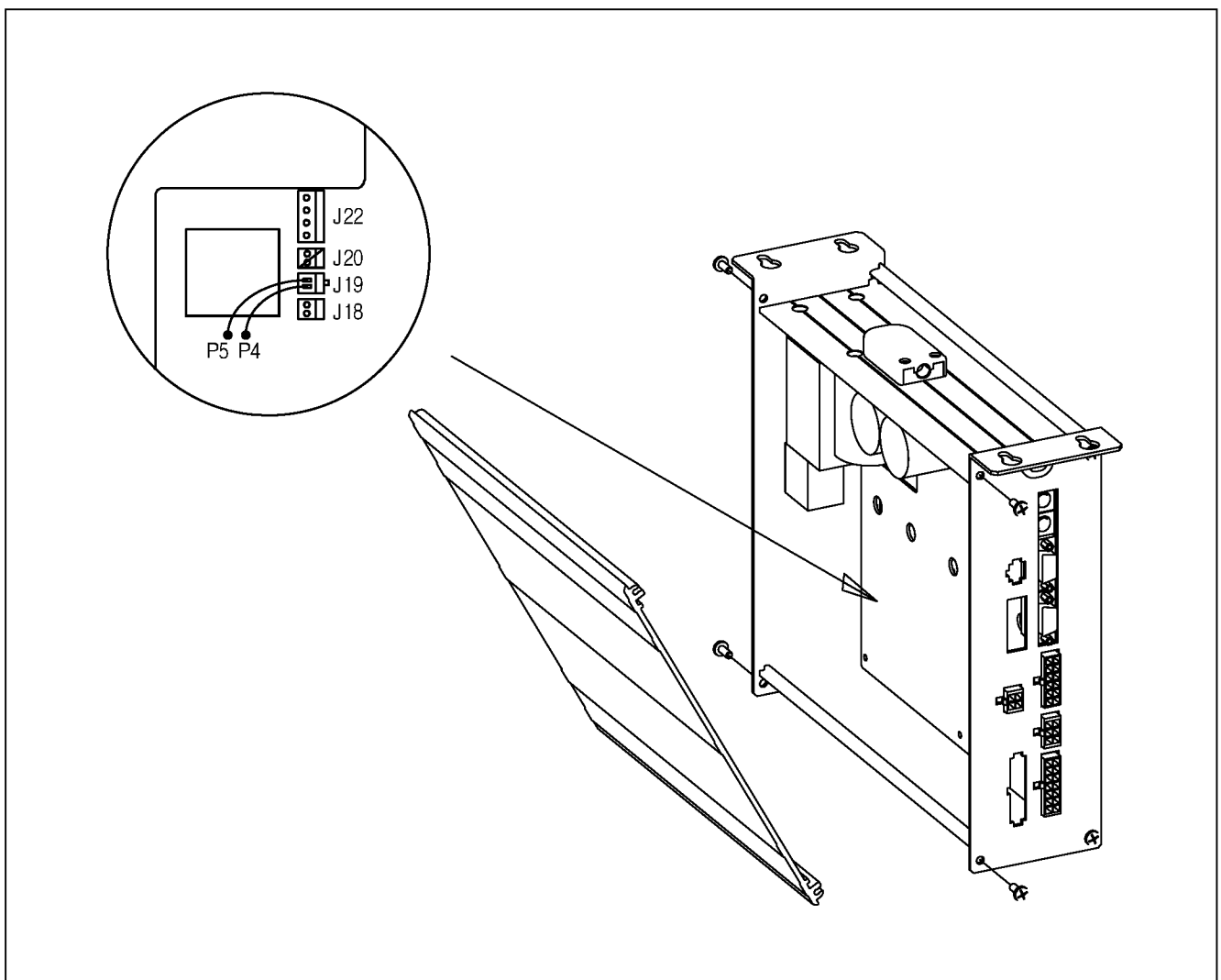

6

CONNECTION THE EARTH WIRE OF THE SEWING MACHINE AND MOTOR

► Method

As in the figure, connect grounding conductors (green or green/yellow) that link the machine and the controller. Check if grounding part of power is connected to the grounding conductors.

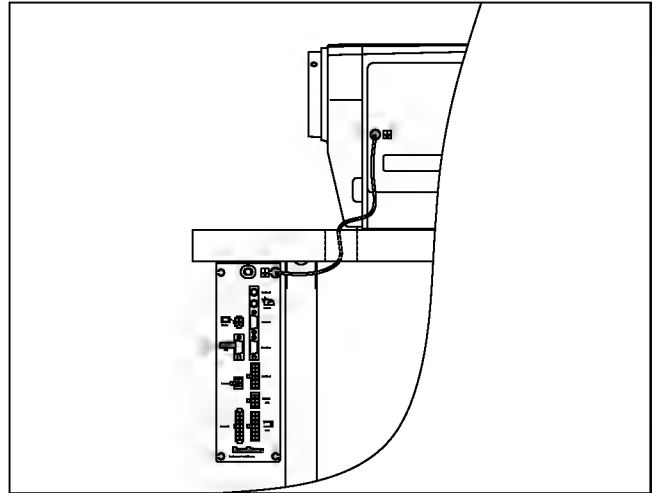

Caution

Failure to ground the motor can cause abnormal operations, such as overspeed rotation or unwanted stitching.

7

THINGS TO BE CHECKED AFTER INSTALLATION

1) Before the power is on...

- ① Make sure that the incoming voltage is in accordance with that shown in the name plate of the Control box.
- ② Check whether the following connectors are connected.
- ③ Check to see the fixing nuts for pulley are tightly fastened.
- ④ Check whether the sewing machines are right kinds (Chain Stitch S/M, Lock Stitch S/M)
- ⑤ Check the rated voltage for Solenoid (Refer to "How to change the electric voltage supplied for Solenoid")

2) After the power is on...

- ① Check whether the program unit is working.
- ② Check the direction of rotation of the Sewing Machine.
 - In case the direction of rotation is not right, action shall be taken to change set it right, referring to "the methods of changing the program and the list of changing functions"(N. 65 in Group "A")
- ③ Check to see whether there are abnormal heat, smell or noise nearby.
 - In case there are, turn the power off and call our regional office.

PROGRAM UNIT PART NAMES AND METHOD OF USE

1) Program unit part names

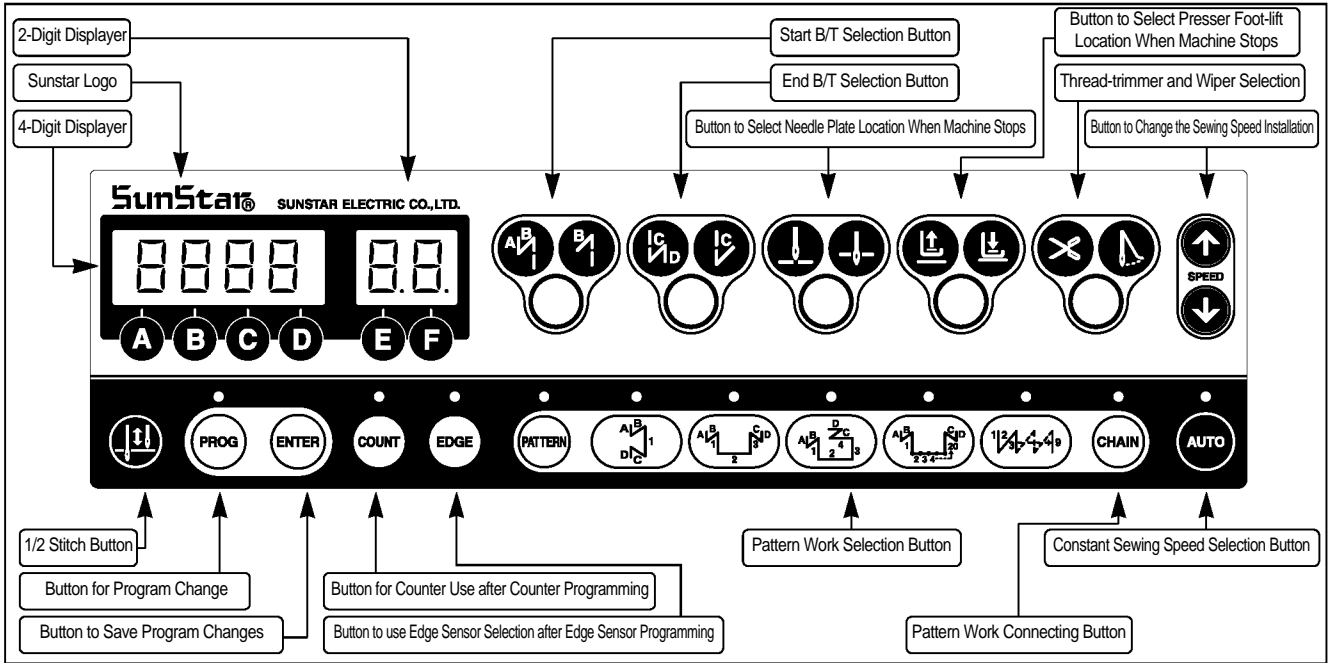

2) Program Unit Method of Use

(1) 4-Digit Displayer and 2-Digit Displayer Functions and Method of Use

A. 4-Digit Displayer and 2-Digit Displayer Functions



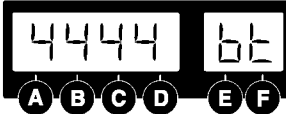

<p>① When you turn the power on, you will see a screen as shown in the figure. The 4-digit displayer shows the start and end B/T sewing and the 2-digit displayer shows the current abbreviation for the letters or numbers shown in the 4-digit displayer (bt: the abbreviation for back tack),</p>	<p><Initializing screen></p>
<p>② The 4-digit displayer shows the error number for each type of error discovered and also shows the programmed value after it has been programmed. The 2-digit displayer shows the number of the parameter specific item's content or name which is shown in the 4-digit displayer.</p>	<p><Example of error detection></p> <p><Example of selection of number 2 item in Group A></p>
<p>[Caution] The 4-digit displayer and 2-digit displayer show the current condition. Therefore the user should always check it before using the machine.</p>	

B. Method of Use: 4-Digit Displayer and 2-Digit Displayer





a. Method to change the start and end B/T stitch numbers

<p>In order to change the start B/T stitch numbers which is programmed when you first purchase this machine, you must use the A, B buttons. If you want to change the end B/T stitch numbers, you must use the C, D buttons.</p> <ul style="list-style-type: none"> The program range is from 0 to 9. <p>(Ex: How the screen looks when changing both start and end B/T stitch numbers to 4).</p>	
--	---

b. Method to check or change the specifics of the parameter





<p>① Press the PROG button and as you press it, also press the A button. Then you can either check or change the programming items for the parameter of group A. (A group : A, B group : B, C group : C, D group : D)</p> <p>※ Users should turn the machine off to select B, C, or D group. While pressing the PROG button, turn the power switch on. The screen will be changed to the initial screen after showing the "PrEn" message. Then, the users can select B, C, or D group by pressing B, C, or D button while holding program PROG button.</p>	
<p>② You can move to the parameter item you want with the E and F buttons. The parameter item number will appear in the 2-digit displayer and the wanted value will appear in the 4-digit displayer.</p> <p>(Ex) Screen showing the maximum speed limit preset in the item 2 of A group)</p>	
<p>③ After using the C (increase) button and D (decrease) button to choose the value you want, press the ENTER (Enter) button and save the value you chose. (Ex: Reducing the maximum sewing speed limit from 4000RPM to 3000RPM).</p>	
<p>④ After saving, press the PROG button and go back to the initial screen.</p>	
<p>[Caution]</p> <ul style="list-style-type: none"> Be aware that if you don't press ENTER after changing the programmed value for the parameter item, the value will not be saved. When the B, C, or D group selection is completed, users should turn off the machine first and restart to secure the selected group. If the user changes the programmed value from the parameter specifics carelessly, the user may cause break down or physical damage to the machine. The user must therefore be well-trained before changing the parameter group. 	

(2) Method of Use : 1/2 Stitch Button Function

<p>① When necessary, make 1/2 stitches by pressing the 1/2 stitch () button.</p>
<p>② When the needle plate makes a down stop, shortly press the 1/2 stitch () button once and the needle plate will make an up stop.</p> <p>And when the needle plate makes an up stop, shortly press the 1/2 stitch () button once and the needle plate will make a down stop.</p>
<p>[Caution]</p> <p>Be aware that if you are continuously pressing the 1/2 () button, the machine will keep on moving at the 1/2 stitch () speed.</p>

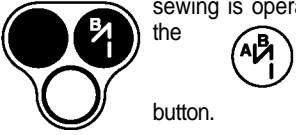
(3) Method of Use: Start B/T Button

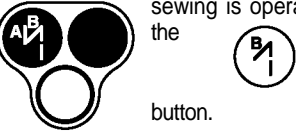
This button is used when the user wants to prevent threads from loosening at the end of the sewing work. If the user presses this button in sequence, the location on the lights will change. This button offers the following three functions.





 <p>When sewing starts, B/T sewing does not operate.</p>	 <p>When sewing starts, B/T sewing is operated with the  button.</p>	 <p>When sewing starts, B/T sewing is operated with the  button.</p>
---	--	--

Using the A, B buttons in the 4-digit displayer, the user can program the B/T number of stitches he/she wants.

[Caution]
Be aware that if the start B/T stitch is set to '0' in the 4-digit displayer, the start B/T sewing is impossible.

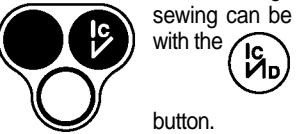
(4) Method of use: End B/T Button

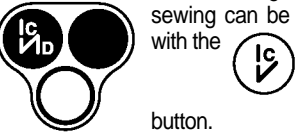
This button is used when the user wants to prevent threads from loosening at the end of the sewing work. If the user presses this button in sequence, the location on the lights will change. This button offers the following three functions.





 <p>When sewing ends, B/T sewing does not operate.</p>	 <p>When sewing ends, B/T sewing can be operated with the  button.</p>	 <p>When sewing ends, B/T sewing can be operated with the  button.</p>
---	--	--

Using the C, D buttons in the 4-digit displayer, the user can program the B/T number of stitches he wants.

[Caution]
Be aware that if the end B/T stitch is set to '0' in the 4-digit displayer, the start B/T sewing is impossible.





(5) Method of Use: The Needle Plate Position Selection Button When the Sewing Machine Stops

When the user turns the power on, one of the up stop or down stop lights in the program unit panel needle plate is always left on. The user can change the stop location by pressing the button.

 <p>When machine stops while sewing, the needle plate makes an up stop.</p> 	 <p>When machine stops while sewing, the needle plate makes a down stop.</p> 
--	---

(6) Method of Use: The Presser Foot-lift Location Selection Button When the Sewing Machine Stops



When the user turns the power on, one of the up stop or down stop lights in the program unit panel presser foot-lift is always left on. The user can change the stop location by pressing the button.

 <p>When the machine stops while sewing, the presser foot-lift stops at the top.</p> 	 <p>When the machine stops while sewing, the presser foot-lift stops at the bottom.</p> 
---	---

[Caution]
 If the user uses the automatic up stop function of the presser foot-lift when the sewing machine stops while sewing, it may cause damage to it because it has been left up for an unnecessarily long time. Be aware that to prevent the foot-presser solenoid from being damaged, it is programmed to automatically come down when a certain amount of time passes.

(7) Method of Use: Automatic Thread Trimmer and Wiper Selection Buttons

These buttons offer the function of automatic trimming and wiping after sewing. By pressing these buttons in sequence, the user can use one of the following three functions. The light shows the function that is currently being used.





 <p>Automatic trimmer and wiper do not operate</p>	 <p>Only automatic trimmer function is operate</p>	 <p>Both automatic trimmer and wiper operate</p>
---	---	---

(8) How to use product counter and bobbin counter

※Product and bobbin counters are functionalities available for Fortuna Series IV option type

① How to set product counter and bobbin counter

A. Set/clear product counter and bobbin counter using the  button in the program unit

Repeatedly press the () button in the program unit to change the status of the lamp and functions as below.	
① When product counter and bobbin counter are not used	 <p><When the lamp is off></p>
② When product counter function is set	 <p><When the lamp is on></p>
③ When bobbin counter function is set	 <p><When the lamp is flashing></p>

※ To use the counter function, set the detailed functions under parameter B-Group.

② How to use detailed functions of product counter and bobbin counter

A. How to use the detailed functions of product counter

To use the counter function, set the detailed functions beforehand.

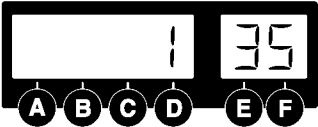
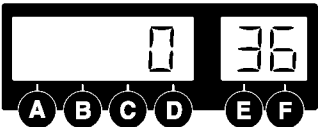
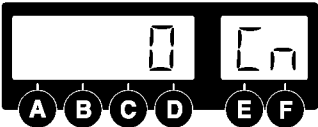
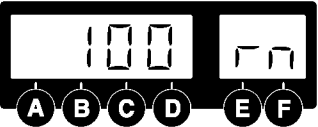
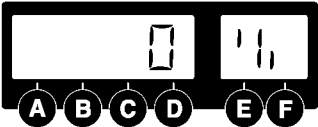
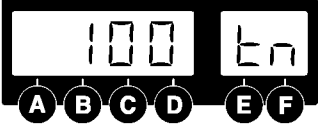
<p>① To use the product counter function, first set the value of the parameter B-35 (group B, item 35) as desired.</p> <ul style="list-style-type: none"> • 0: Set the external counter switch on • 1: Set the automatic counter on after trimming <p>※ As the default value is set "0", the counter will not run if there is no external counter switch.</p>	
<p>② Set the parameter B-36 to select the type of product counter</p> <ul style="list-style-type: none"> • 1: Up counter • 0: Down Counter <p>※ The default value is set at "1".</p>	
<p>③ Press the counter F button to set the counter function. Press the button to check and set the detailed data of the counter.</p> <ul style="list-style-type: none"> • Cn: The current counter amount • rn: The remaining amount • %: The progress • tn: Total target amount (Default: 100) <p>※ Press F button repeatedly to see the above detailed data in order. The user may set up the current counter amount (Cn) and the total target amount (tn) as desired.</p>	<p><The current amount></p>  <p><The remaining amount></p> 
<p>④ After the total target amount is set, use B-37 and B-38 to set the movements.</p> <p><Set value of B-37></p> <ul style="list-style-type: none"> • 0: When work is finished, the buzzer will go off and sewing may begin • 1: When work is finished, the buzzer will go off and sewing may begin only when the PROG button is pressed • 2: When work is finished, the buzzer will not go off and sewing may begin <p><Set value of B-38></p> <ul style="list-style-type: none"> • 0: No returning to automatic initial value when counting is complete • 1: Returning to automatic initial value when counting is complete 	<p><The progress></p>  <p><Total target amount></p> 
<p>[Caution] When B-38 is set at "0", the value will keep on going up/down even when counting is complete. The user will need to re-set the value of Cn to restart.</p>	



B. How to use the detailed functions of bobbin counter

Bobbin counter is designed to check the remaining amount of the lower thread.

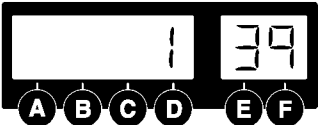
a. To use the counter, set detailed functions beforehand.

<p>① To use the bobbin counter function, first set the value of the parameter B-39 (Group B, item 39).</p> <ul style="list-style-type: none"> • 0: Bobbin counter function not used • 1: Bobbin counter function used <p>※ The default value is set at “0”. At this point, the bobbin counter will not start even when the counter button in the program unit is set at bobbin counter function.</p>	
---	---

b. Detailed functions of bobbin counter

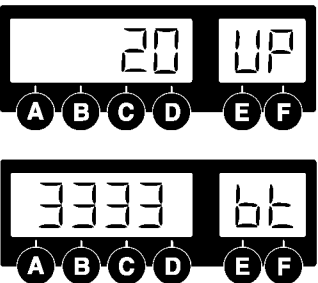

<p>① Select the bobbin counter function by pressing  button to get the lamp flashing. Press F button and the display will change as shown in the right. “bc” stands for bobbin counter.</p>	
---	---

<p>② At this point, press F button to change the display to “UP”. Press F button again to go back to the initial display of “3333 bt”. Press F again to change to “bc” as explained in ①. The display will change by pressing F button.</p>	
---	---

<p>• [bc]</p>	<p>It stands for the Bobbin Counter; the value will be increased from “0”. (Initial value: 0, Set range: 0~9999, How to set: use C / D button)</p>
<p>• [UP]</p>	<p>This value will go up in proportion to the increasing ratio of “BC(Bobbin Counter)”. Use this value to get the initial value of “BC(Bobbin Counter)” (Initial value: 0, Set range: 0~9999, Set manual increase/decrease function with C/D button)</p>
<p>• [bt]</p>	<p>Back-tack function that is shown in the initial display</p>

[Caution]



※ Pay caution when using  button, designed to perform special functions for bobbin counter.

-  button (Store counter value) : Press  button when “bc” or “UP” is shown on the display. The current indicated value will be stored as value of bobbin counter.

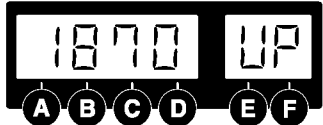
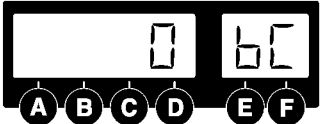
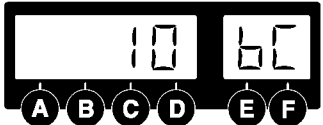
c. Setting Bobbin Counter Functions

<p>① When you start new sewing work, you must re-set the value of bobbin counter. Refer to the following if you do not know your re-set value.</p> <ul style="list-style-type: none"> • First move to “UP” display and use C , D button to change the value to “0”. • Replace old lower thread with the new one. The amount of the lower thread must be consistent. • Begin sewing. The more you sew, the higher the value of “UP” will be. • Continue sewing until you run out of the lower thread. • When there is no lower thread left during sewing, press ENTER button to store the counted value. • Before saving, subtract some 10~20 from the value in order to reflect the counted value after the lower thread ran out. 	 
<p>② When the bobbin counter setting is complete, move to “bc” display.</p>	
<p>③ The value of “BC(Bobbin Counter)” increases gradually when sewing begins after completing set-up.</p>	
<p>[Caution]</p> <p>※ Before using the bobbin counter function, move to “bc” display or initial display. If you start working from “UP” display, the value of counter will go up.</p>	

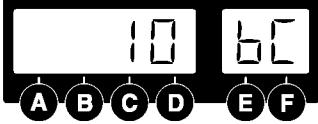
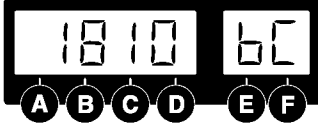
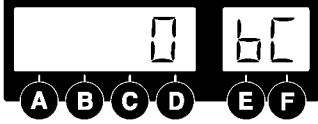
d. When bobbin counter is complete

<p>① Replace the old lower thread with the new one and start sewing, then the value of “BC(Bobbin Counter)” will go up gradually.</p> <p>② Take note that the buzzer will go off when the value goes up, and the gap between that value and setting value narrows under 20. This is to warn that there is little lower thread left.</p>	 
<p>③ The value of Bobbin Counter is reached at setting value, the stitching will be stopped and the buzzer will go off and the monitor will start blinking.</p>	
<p>④ When sewing stops after counting is complete, use the following method to return.</p> <ul style="list-style-type: none"> • Press the  button to change the value of “BC” to the “0” automatically. (AUTO CLEAR/PRESET) 	
<p>[Caution]</p> <ul style="list-style-type: none"> ※ To use the bobbin counter function, first set B-Group 39 to “1.” ※ Use  button to change the display to set/clear the value of bobbin counter during sewing. ※ Wind the lower thread with consistency to ensure the proper use of bobbin counter functions. Counter functions may work differently depending on lower thread and sewing conditions. 	

(9) Method of Use: Pattern Work Selection Button



A. Method to Set Up the Pattern Work Function

<p>This function is used when you need to continuously work on a sewing material. If the light goes on after pressing the button, you can use the pattern sewing function.</p>	
--	--

B. Method of Use of Pattern Sewing Specific Functions

<p>① Cautionary words when using the pattern function</p> <ul style="list-style-type: none"> • Before using the pattern function, finish the trimming work and turn on the pattern switch light. • If the user presses the pattern switch twice when he/she is not using the pattern function, the light will go off and he/she will be able to go back to normal sewing. However, if the pattern mode has not been completely finished, the pattern light will not go off. • The pattern function sewing speed will be the programmed speed. • The value set in each pattern mode is not erased when the power is turned off. Therefore, if you want to use the same pattern again, press the same mode again to use it. However, if the program is initialized, all the formerly programmed information will be erased and the user must reset the information again. 	
<p>② Method of use: function</p> <p>Ⓐ first press the button and select the pattern sewing function.</p> <p>Ⓑ Select the pattern you want and the light will go on the pattern you selected.</p> <p>Ⓒ If you press the button, the screen will change and you can use the stitches of each side of the pattern you chose to program the value.</p> <p>< Method to program the value of each pattern side ></p> <ul style="list-style-type: none"> • Method by using the , buttons <ul style="list-style-type: none"> – Inputting directly the number of stitch the user wants by using the buttons C and D. This method is used when the user already knows the length of the stitches he/she is choosing. • Method using the pedal movement <ul style="list-style-type: none"> – This is a function used when the user does not know the stitch length and sews directly to check the number of stitches for the pattern he/she wishes to program. If the user presses on the pedal after the programming screen comes on, the pedal can program the number of stitches by using the accelerating and decelerating characteristics through the pedal's sensors. The standard for choosing the number of stitches here is slower than the normal sewing speed and the programmed pattern sewing speed. • Method using the A button and 1/2 stitch button <ul style="list-style-type: none"> – This function is used when the user needs to make small adjustments at the end of the pattern work. It allows the user to check and program the pattern length while he/she sews at a slow speed or sews half stitches. 	<p><Screen showing the programming of stitch numbers for each side></p> <p>P : When the AUTO light is off, the machine stops when the pedal is released while sewing.</p> <p>A : When the AUTO light is on, the machine will finish sewing the pattern section even if user releases pedal while sewing.</p>
<p>Ⓓ After programming is finished, press the button and save the set up value. Then press the button. After the stitch numbers of each side disappear from the screen, you can start sewing with the programmed value in the pattern sewing function.</p> <p>Ⓔ The pattern sewing speed is constant because it sews at a programmed speed not by the acceleration or deceleration of the pedal. If you press the pedal after pressing the button and see the light blink, sewing will continue until it is finished even if you release the pedal.</p>	
<p>[Caution]</p> <ul style="list-style-type: none"> • After setting each side of the stitches, the user must press the button to save the programmed value. • When the pattern has more than one side, the pattern work only operates for the number of stitches programmed for each side. 	

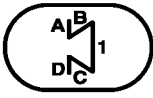
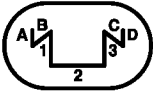
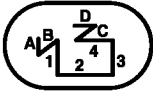
③ Specific items of each pattern

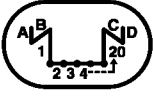
	<p>A convenient pattern for straight sewing at constant speed for a definite length. The sides can be set from 0 to 999 stitches.</p>
	<p>A convenient pattern for repetitive 3-sided sewing. Each side can be set from 0 to 999 stitches.</p>
	<p>A convenient pattern for 4-sided sewing. Each side can be set from 0 to 999 stitches. (Used often in square sewing)</p>
	<p>A convenient pattern when forward/backward sewing is needed continually. forward/backward sewing is possible 9 times. Also each side can be set from 0 to 999 stitches. (This pattern is used for continuous work on back tags of leather belt rings).</p>
	<p>A convenient pattern when the user wants to make many-sided patterns. The user can make patterns of up to 20 sides. Each side can be set from 0~999 stitches.</p>

④ Method of Use : Chain function (pattern linking function)

- First press the **(PATTERN)** button and select the pattern sewing function
- Next, press the **(CHAIN)** button.
- If you press the **(PROG)** button, the screen will change as the figure shows on the right. You can change the number of chains with buttons **E**, **F**.
- If you want to program the number of chains in the pattern you want, use buttons and, to go to the item you want and press the pattern button.
- After programming the chain numbers as explained above, press the **(ENTER)** button and the change of value will be saved. Then press the **(PROG)** button to come out from the chain programming screen.
- If you operate the programmed sewing work, the pattern with the blinking light is the current work being done and the pattern with the light on continuously is the next programmed pattern.

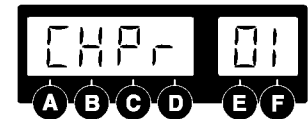

[Caution]

- After programming the chain function and pressing the **(ENTER)** button, the set up value is saved.
- If you change the pattern program while sewing, it will sew with the new programmed pattern.
- If the last chain pattern is finished, it will automatically go to the first sewing pattern.





※ If the user presses the **(AUTO)** when using the pattern sewing function, the **(AUTO)** light will go on and the machine will automatically sew the programmed pattern section even if the user releases the pedal.

(10) Method of Use: Constant Speed Sewing (AUTO) Selection Button







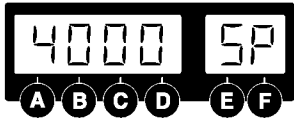

<p>This button is used to choose the sewing speed. It offers two functions according to where the light turns on.</p>	
	<ul style="list-style-type: none"> • When the light is blinking - If the user presses on the pedal, the machine will sew at the programmed sewing speed.
	<ul style="list-style-type: none"> • When the light is off - The machine will sew according to the amount of pressure given to the pedal by the user.
<p>[Caution] This button works in a different way when using the pattern function. Please refer to section 10).</p>	

(11) Method of Use: Sewing Speed Program Changing Button

A. Method to Check Sewing Speed

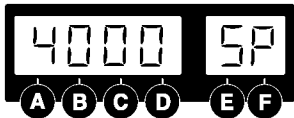
<p>If you want to check the current programmed sewing speed, you must press the button. If you briefly press the  button  button once, the screen shown on your right will appear briefly and then return to the initial screen.</p> <p>※ The speed on the screen is the limit of the maximum sewing speed.</p>	
<p>[Caution] The maximum speed and minimum speed limits can be changed by changing the parameter's specific items.</p>	

B. Sewing Speed Changing Method

<p>① When you want to change the sewing speed, you can see the screen that shows the current sewing speed by pressing the  button or  button.</p> <p>② If you see the current speed on the screen, you can change the speed by using the  and  button before going back to the initial screen.</p> <ul style="list-style-type: none"> • When you press the buttons twice in sequence: The sewing speed increases/decreases by 40RPM. • When you keep pressing the button: The sewing speed increases/decreases rapidly. 	  
<p>[Caution]</p> <ul style="list-style-type: none"> -Be aware that if you don't press the  or  button, the screen will automatically go back to the initial screen. -The maximum speed and minimum speed limits can be changed by changing the parameter's specific items. 	

3) Start and End Backtack Stitch Correction Method

- ※ Since backtack stitches may vary according to the type of sewing machine, use the following stitch correction method.
- ※ To adjust the stitch fast and clean, users should check the stitch condition before commencing the correction.

① Classification according to backtack sewing condition

- ※ The backtack sewing condition can be classified as follows (When A: 3 stitches, B: 3 stitches, C: 3 stitches, D: 3 stitches)

A. When one more or less stitch than the set stitch number is sewn

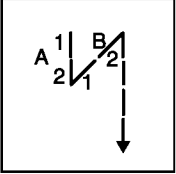
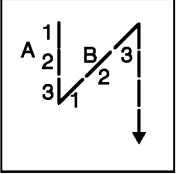
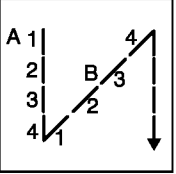
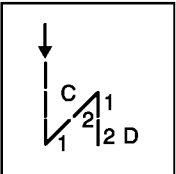
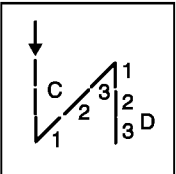
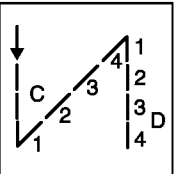
Classification	Sewing condition where few backtack stitches are sewn	Correct backtack sewing condition	Sewing condition where more backtack stitches are sewn
Start backtack Sewing condition	 <p>When sides A and B each have one less stitch sewn</p>	 <p>When sides A and B each have 3 stitches correctly sewn</p>	 <p>When sides A and B each have one more stitch sewn</p>
End backtack Sewing condition	 <p>When sides C and D each have one less stitch sewn</p>	 <p>When sides C and D each have 3 stitches correctly sewn</p>	 <p>When sides C and D each have one more stitch sewn</p>

B. When one more or one less stitch is sewn than the programmed stitch number

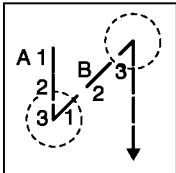
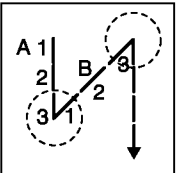
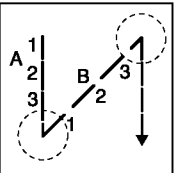
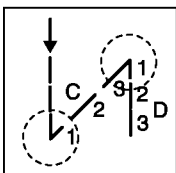
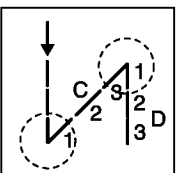
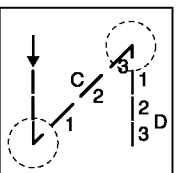
Classification	B/T condition where the stitch length comes out shorter	Correct B/T sewing condition	
Start backtack Sewing condition	 <p>When the length of the last three stitches in sides A and B have been sewn short.</p>	 <p>When sides A and B have 3 stitches correctly sewn.</p>	 <p>When sides A and B each have 3 stitches and a half stitch (or less than one stitch) sewn</p>
End backtack Sewing condition	 <p>When the length of the first stitch in sides C and D have been sewn short.</p>	 <p>When the sides of C and D have 3 stitches correctly sewn</p>	 <p>When the sides of C and D each have 3 stitches and a half stitch (or less than one stitch) sewn.</p>

[Caution]

The figures above show each representative sewing condition. And there may be some differences according to the conditions of the sewing machine and it is normal that two types of conditions occur at the same time.

② Start/End B/T stitch number correction method

※ The method to correct B/T stitch numbers may differ according to the user. However it is basically done in the following order.

A. When the machine sews one less or one more stitch than the programmed number of stitches.

<p>Ⓐ First, fully check the B/T sewing condition : Commence sewing and check the current sewing condition. Refer to the figure above.</p>	<p style="text-align: center;"><Initial screen></p>								
<p>Ⓑ If you have checked the sewing condition, first correct the stitch number that differs by one or more stitches to the programmed stitch number.</p> <p>※ Correction method for stitch numbers with more than one stitch difference</p> <ul style="list-style-type: none"> • Program range: -6 stitches ~ 6 stitches • Program unit: 1 stitch • Method to apply correct stitch number (program using buttons A, B, C and D). <table border="1" style="width: 100%; border-collapse: collapse; margin: 10px 0;"> <tr> <td style="padding: 2px;">Side A programmed value</td> <td style="padding: 2px;">$3(\text{programmed stitch number}) + (3-\text{actual stitch number sewn on side A})$</td> </tr> <tr> <td style="padding: 2px;">Side B programmed value</td> <td style="padding: 2px;">$3(\text{programmed stitch number}) + (3-\text{actual stitch number sewn on side B})$</td> </tr> <tr> <td style="padding: 2px;">Side C programmed value</td> <td style="padding: 2px;">$3(\text{programmed stitch number}) + (3-\text{actual stitch number sewn on side C})$</td> </tr> <tr> <td style="padding: 2px;">Side D programmed value</td> <td style="padding: 2px;">$3(\text{programmed stitch number}) + (3-\text{actual stitch number sewn on side D})$</td> </tr> </table> <p>• After programming, press the and buttons simultaneously.</p> <p>Ex) When there is one less Start or End B/T stitch sewn.</p> <div style="display: flex; justify-content: space-around; margin: 10px 0;"> </div>	Side A programmed value	$3(\text{programmed stitch number}) + (3-\text{actual stitch number sewn on side A})$	Side B programmed value	$3(\text{programmed stitch number}) + (3-\text{actual stitch number sewn on side B})$	Side C programmed value	$3(\text{programmed stitch number}) + (3-\text{actual stitch number sewn on side C})$	Side D programmed value	$3(\text{programmed stitch number}) + (3-\text{actual stitch number sewn on side D})$	
Side A programmed value	$3(\text{programmed stitch number}) + (3-\text{actual stitch number sewn on side A})$								
Side B programmed value	$3(\text{programmed stitch number}) + (3-\text{actual stitch number sewn on side B})$								
Side C programmed value	$3(\text{programmed stitch number}) + (3-\text{actual stitch number sewn on side C})$								
Side D programmed value	$3(\text{programmed stitch number}) + (3-\text{actual stitch number sewn on side D})$								
<table border="1" style="width: 100%; border-collapse: collapse;"> <tr> <td style="padding: 2px;">a In the initial screen use buttons , , , to change it from "3 3 3 3" to "4 4 4 4."</td> </tr> <tr> <td style="padding: 2px;">b After programming it to "4 4 4 4" press the button. Then press the 1/2 stitch button. You will see the letters "bt-C" and the buzzer will ring three times and the screen will automatically return to the initial screen.</td> </tr> <tr> <td style="padding: 2px;">c The changed initial screen will continue to display the wanted B/T programmed value of "3 3 3 3."</td> </tr> <tr> <td style="padding: 2px;">d Recommence sewing and check the corrected stitch number</td> </tr> <tr> <td style="padding: 2px;">e If the corrected sewing condition continues to show more than one stitch difference, repeat steps (a~d) and make corrections.</td> </tr> </table> <p>※ The example above is an explanation of when one B/T stitch number comes less than one</p> <p>※ When there is more than one stitch is added or missing, you can correct the stitch number as explained above.</p>	a In the initial screen use buttons , , , to change it from "3 3 3 3" to "4 4 4 4."	b After programming it to "4 4 4 4" press the button. Then press the 1/2 stitch button. You will see the letters "bt-C" and the buzzer will ring three times and the screen will automatically return to the initial screen.	c The changed initial screen will continue to display the wanted B/T programmed value of "3 3 3 3."	d Recommence sewing and check the corrected stitch number	e If the corrected sewing condition continues to show more than one stitch difference, repeat steps (a~d) and make corrections.				
a In the initial screen use buttons , , , to change it from "3 3 3 3" to "4 4 4 4."									
b After programming it to "4 4 4 4" press the button. Then press the 1/2 stitch button. You will see the letters "bt-C" and the buzzer will ring three times and the screen will automatically return to the initial screen.									
c The changed initial screen will continue to display the wanted B/T programmed value of "3 3 3 3."									
d Recommence sewing and check the corrected stitch number									
e If the corrected sewing condition continues to show more than one stitch difference, repeat steps (a~d) and make corrections.									
<p>[Caution]</p> <p>※ The stitch number correction value program range is between -6 stitches to 6 stitches. You cannot see the currently applied correction value on the initial screen. If you want to see the currently applied correction value, press the button and then the button and either check the programmed value of each side or check items 30(side A's correction value), 31(side B's correction value), 32(side C's correction value) and 33(side D's correction value) from Group B of the parameter.</p> <p>※ If each side's corrected value has been corrected to the minimum or maximum value limit (between -6 stitches to 6 stitches) and the sewing condition is still not correct, reduce the B/T sewing speed.</p> <p>※ Generally, you can correct in the manner mentioned above when there is more than one stitch difference. And you can correct when there is less than one stitch difference with the item mentioned in the next page.</p>									

B. When the machine sews less than a stitch more or less than the one programmed.

- a) If there are still problems with the B/T sewing condition even after correcting the stitch numbers for more than one stitch difference based on item "A," refer to figure ①-B and check the sewing condition again.

- b) Look at the sewing condition and make the correction as follows:

- ※ Program range for making stitch corrections for less than one stitch:(Prog+Auto)
 - -6 stitches ~ 6 stitches
 - Program unit: 0.05 stitches (Corrections are done by dividing one stitch into 20 parts).
 - Initial program: A(00.30), B(00.30), C(00.40), D(00.40)
 - Correct stitch number application method (use C and D buttons for programming).
- ※ When the stitch length comes out short(the third stitch of sides A and B/ the 1st stitch of sides C and D)

Side A program value	□□ □□ (Currently programmed corrected value)
	+ (01.00-the length of the 3rd stitch sewn in side A)
Side B program value	□□ □□ (Currently programmed corrected value)
	+ (01.00-the length of the 3rd stitch sewn in side B)
Side C program value	□□ □□ (Currently programmed corrected value)
	+ (01.00-the length of the 1st stitch sewn in side C)
Side D program value	□□ □□ (Currently programmed corrected value)
	+ (01.00-the length of the 1st stitch sewn in side D)







- ※ <When the stitch comes out less than one stitch longer> (the last stitch of sides A and B/ and the first stitch of sides C and D)

Side A program value	□□ □□ (currently programmed correction value)
	- the length of the extra part of the stitch sewn on side A
Side B program value	□□ □□ (currently programmed correction value)
	- the length of the extra part of the stitch sewn on side B
Side C program value	□□ □□ (currently programmed correction value)
	- the length of the extra part of the stitch sewn on side C
Side D program value	□□ □□ (currently programmed correction value)
	- the length of the extra part of the stitch sewn on side D

[Caution] • The shadowed part is the currently saved correct value.

- After programming, press the  button and save the programmed value.

Ex) When the Start/End B/T stitch length is shorter than the programmed stitch length (by around half a stitch).

- a. In the initial screen, press the  button and then also press the  button.
- b. The screen will then go to the stitch number correction screen. Using the ,  buttons you can change the length of each side (A,B,C and D) in this screen.
- c. If you have finished programming the new correction values to sides A, B, C and D, press the  button and save the corrected value. If you press the  button, you will return to the initial screen. (A:00.30, B:00.30, C:00.40, D:00.40) → (A:00.50, B:00.50, C:00.75, D:00.75)
- d. Commence sewing and check the B/T sewing condition.
- e. If the corrected sewing condition still shows differences between the programmed value, the repeat steps (a-d) and continue correction.

<Initial screen>

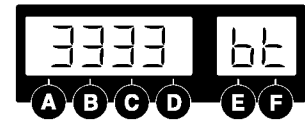

<When the stitch length comes out short>

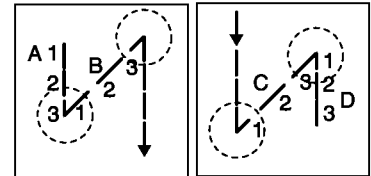

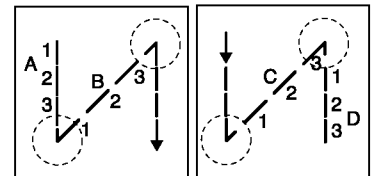

<When the stitch length is less than one stitch>



[Caution]

- ※ If each side's corrected value has been corrected to the minimum or maximum value limit (between -6 stitches to 6 stitches) and the sewing condition is still not correct, reduce the B/T sewing speed.
- ※ Generally, you can correct for when there is more than one stitch difference with item A. However, with item B, you can correct when there is either more or less than one stitch difference.
- ※ Make sure to press the  button and save the programmed value when you finish programming sides A, B, C and D's new correction value.

4) Method of Use: Inertia Tuning Function

<p>① The inertia tuning function enables the machine to save the gain value of the motor that matches the loaded inertia. If you simultaneously press buttons PROG and ENTER, you will see the inertia tuning screen. Then, you will see the words "TUNE" blinking.</p>	<p><Inertia tuning initial screen></p>  <p><Initial screen></p> 
<p>② When the screen changes, you must press the pedal until the buzzer rings. If you release the pedal before the buzzer rings the inertia tuning won't be completed. Therefore, you must press on the pedal until the buzzer rings. (When doing inertia tuning, the sewing machine will operate and stop 10 times).</p>	
<p>③ When inertia tuning is completed, the buzzer will ring and it will automatically return to the initial screen.</p>	
<p>[Caution] Inertia tuning can only be carried out when the controller is attached to the sewing machine for the first time and when the sewing machine does not accelerate or decelerate quickly.</p>	

5) Sewing machine head open error and safety switch error

- ① Sewing machine head open error function is available for KM-2300 series. When the sewing machine head is lifted during sewing or with the power switch on, "oPEn Er" will show with a buzzer sound and sewing will stop.

Description	Symptoms and troubleshooting
<p>① When the machine head is lifted with the power switch on</p>	<ul style="list-style-type: none"> • "oPEn Er" will appear. • The error indication will disappear when the machine head is put back to its original position, and sewing may begin.
<p>② When the machine head is lifted during sewing</p>	<ul style="list-style-type: none"> • "oPEn Er" will appear. • If the error message remains even after putting the machine head to its original position, turn the power off first and turn it back on to continue sewing.
<p>③ When the machine head is in its original position</p>	<ul style="list-style-type: none"> • When "oPEn Er" message appears even when the machine head is in its original position, be sure to check the following. <ul style="list-style-type: none"> - Check the switch attached under the right side of the machine head - Check the set value of parameter C-61 : In case of KM-2300 Series and KM-1750/1790 Series, the value set for No. C-61 shall be "20" and "120" respectively.

- ② Safety switch error function is available for SC-7300 series. The error message will show when the blade does not return to its original position during trimming

Description	Symptoms and troubleshooting
<p>① When the error appears during sewing</p>	<ul style="list-style-type: none"> • "SF22 Er" will appear. • Check if the blade of the sewing machine has returned to its original position.
<p>② When the error appears immediately after sewing starts after turning the power on</p>	<ul style="list-style-type: none"> • If "SF22 Er" message appears after you turn the power on and begin sewing, be sure to check the following. <ul style="list-style-type: none"> - Check the safety switch attached on the back of the sewing machine - Check the set value of parameter: The value of C-61 must be set at "111."

6) How to Use Edge Sensor

(1) Installing the Edge Sensor

- ① Attach the edge sensor bracket to the sewing machine head as in the figure.
- ② Insert the edge sensor into the attached edge sensor bracket.

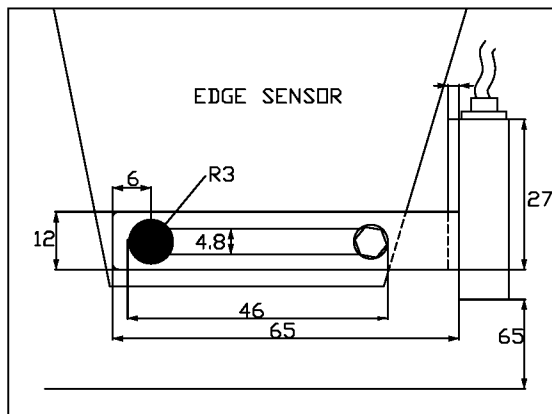

< KM-235,250 >

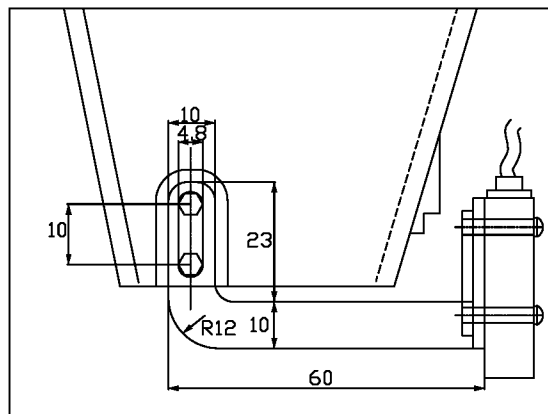

< KM-750,790 >

- ① Attach the edge sensor box (ass'y) connected to the edge sensor to the table.
- ② Link the edge sensor connector to the switch connector.

[Pin Number]						
14	13	12	11	10	9	8
7	6	5	4	3	2	1

1, 2, 7 : GND	9 : 4/4
3 : Left switch LED	10 : 3/4
4 : Right switch LED	11 : 2/4
5 : Left switch	12 : 1/4
6 : Right switch	13 : Switch-HALF
8 : VCC (5[V])	14 : Switch-CNT

(2) Edge Sensor Setup





<p>① While the PROG button is being pressed, turn on the power.</p>	
<p>② While the PROG switch is being pressed, press C button to enter the Parameter C Group.</p>	
<p>③ Use the E and F buttons to set the Parameter C Group at 52. Use the C and D buttons to change the value of 2 to 12.</p>	
<p>After going through the above processes ①~③, press ENTER to save the new value. Press the PROG button to exit the parameter setup mode.</p>	
<p>After undergoing the above processes ①~④, press the EDGE button. When the LED is on, the sensor is working.</p>	

	<p>Pressing the edge sensor button makes sewing motion stop when the sewing material edge is detected. For proper implementation of the function, have a thorough understanding of "Section (4) Use of Detailed Edge Sensor Functions" in the manual before use.</p>
--	--

(3) Edge Sensor Sensitivity Setup

<p>① Without a sewing material located under the sensor, set the operating mode on the back of the sensor at L.ON.</p>	
<p>② Press the EDGE button and the lamp blinks. Place a sewing material under the sensor and check if the STB lamp (amber) in front of the sensor blinks.</p>	
<p>③ In the event that the STB lamp(amber) in front of the sensor is not turned on, change the operating mode on the back of the sensor to D.ON and repeat the process② again. (The reason of the lamp turned off is the edge sensor reacts depending on sewing material types.)</p>	
<p>④ After undergoing the above processes ①~③, adjust the SENS volume on the sensor front to make sure that the OPL lamp(Red) remains turned off when the sewing material is below the sensor and that the OPL lamp(Red) blinks when the sewing material is not below the sensor. At this time, the blinking of the STB lamp(amber) does not matter.</p>	

(4) Use of Detailed Edge Sensor Functions

<p>① While the PROG button is being pressed, press the A button to enter the Parameter Group A. (Entry into the parameter group is allowed only after trimming.)</p>					
<p>② Use the E and F buttons to set the parameter numbers subject to revision. Use the C and D buttons to change parameter values.</p>					  
A-Group	Function	Initial Value	Scope	Stage	
41	Sensor type select	0	0 : When the edge is sensed, 5[V] output(Active High) 1 : When the edge is sensed, 0[V] output(Active Low)		
42	After the edge is sensed, set the stitch count to proceed	3[stitches]	0~255[stitches]	1[stitches]	
43	After the edge is sensed, set the sewing speed for the stitches.	1000[rpm]	20~2000[spm]	10[spm]	
<p>③ Change each parameter value and save the new value by pressing the ENTER button.</p>					

 Caution	<p>1. Note that a new value is not saved without pressing the ENTER button after parameter value reset.</p> <p>2. If the system is initialized, all data is recovered back to the initial values.</p>
---	--

(5) Edge Sensor Motion

<p>① Press the EDGE button to activate the edge sensor.</p>	
<p>② If the edge sensor is activated, when the sewing material edge is detected, the sewing is suspended (distance between the needle and the sewing material edge: some 20[mm]).</p>	
<p>③ When the sewing is suspended as in ②, move the pedal from “Neutral” to “Forward” and then the sewing is resumed at the stitch count set at Parameter A-42 at the speed set at Parameter A-43.</p>	
<p> After completing the process ③ and conducting trimming (pedal backward), the backtack sewing for finish (in the case where the backtack lamp is blinking) and trimming are performed in order.</p>	

(6) Deactivating Edge Sensor

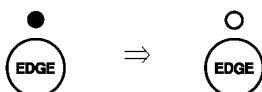
<p>① Press the EDGE button to turn off the lamp and then the edge sensor is deactivated.</p>	
---	---

7) Motor Controller Setting

(1) Controller Setting by Machine Type

Classification	Machine Type	Set Value for Parameter B-56 Model	Remarks
1	SC-7300 Series	88	Parameters are set according to the ordered specifications before machine's shipment from the factory.
2	SC-7500 Series	124	
3	SC-7310 Series	125	

※ Model Number Setting

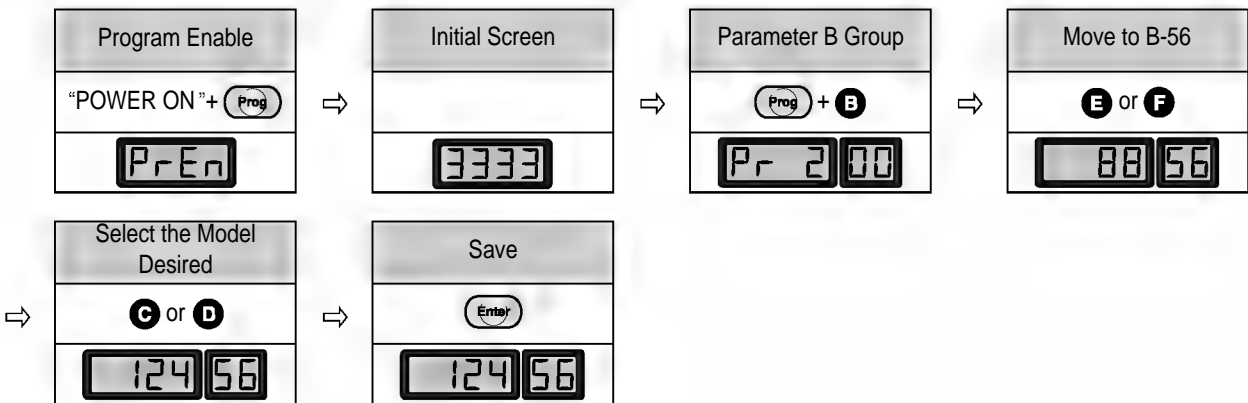

[Note]

- ① Before the product is shipped out from the factory, all settings are completed in line with the machine type ordered.
- ② In case where the controller which is different from the ordered specifications is installed to the chain-type machine:
 - ⇒ Set the value of parameter B-56 according to the concerned machine type.
 - ⇒ Depending on the program version of controller, it may not be applicable to some machines. See the following to make the proper setting according to the machine type.

※ Version display

- ▶ When the power is turned on, the CPU version is displayed as below on P/U for a moment, and then the screen moves to the initial screen ("3333").

Classification	Fortuna Series III(CPU version 11)	Fortuna Series IV(CPU version 7)
Program Unit (P/U)	5Er3 11	5Er4 07
Handy Controller	5Er3 ⇒ 11	5Er4 ⇒ 07

- ▶ This is an old version where the CPU version is not displayed.

(2) In case where the top thread trimming device is installed

Make a setting based on the check points below to ensure proper operation of the top thread trimming device when the top thread trimming device is installed.

① Make the setting as below depending on the program version of the controller.

Program version		Setting
1	S-III version "11" or above	Set the value of Parameter A-73 at "1"
	S-IV version "7" or above	
2	Lower than S-III version "11"	Modify the trimming sequence of Parameter B-55.
	Lower than S-IV version "7"	

② Modification of the sequence of Parameter B-55

▣ Using the external program unit

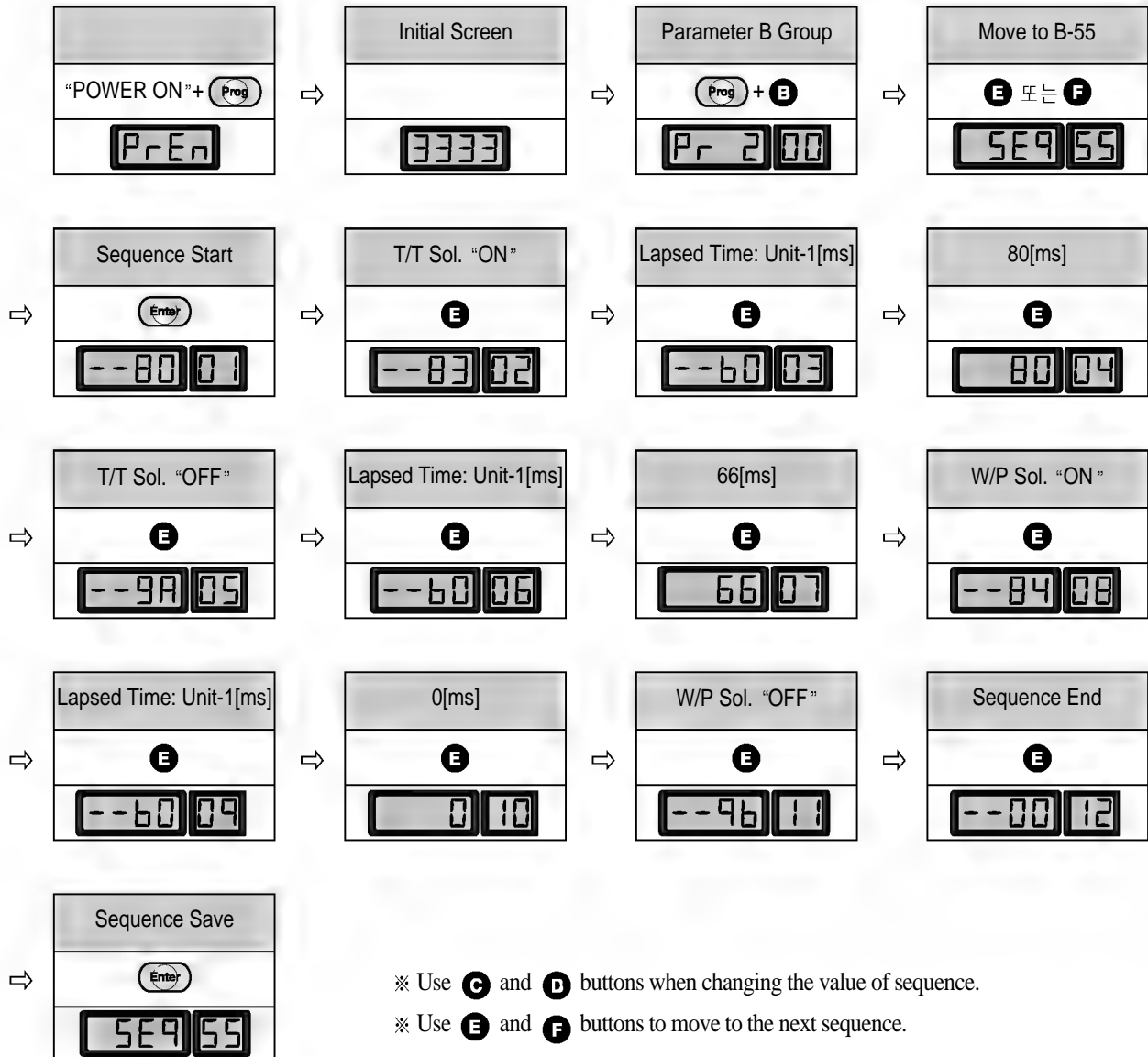

▣ How to use the imbedded handy controller

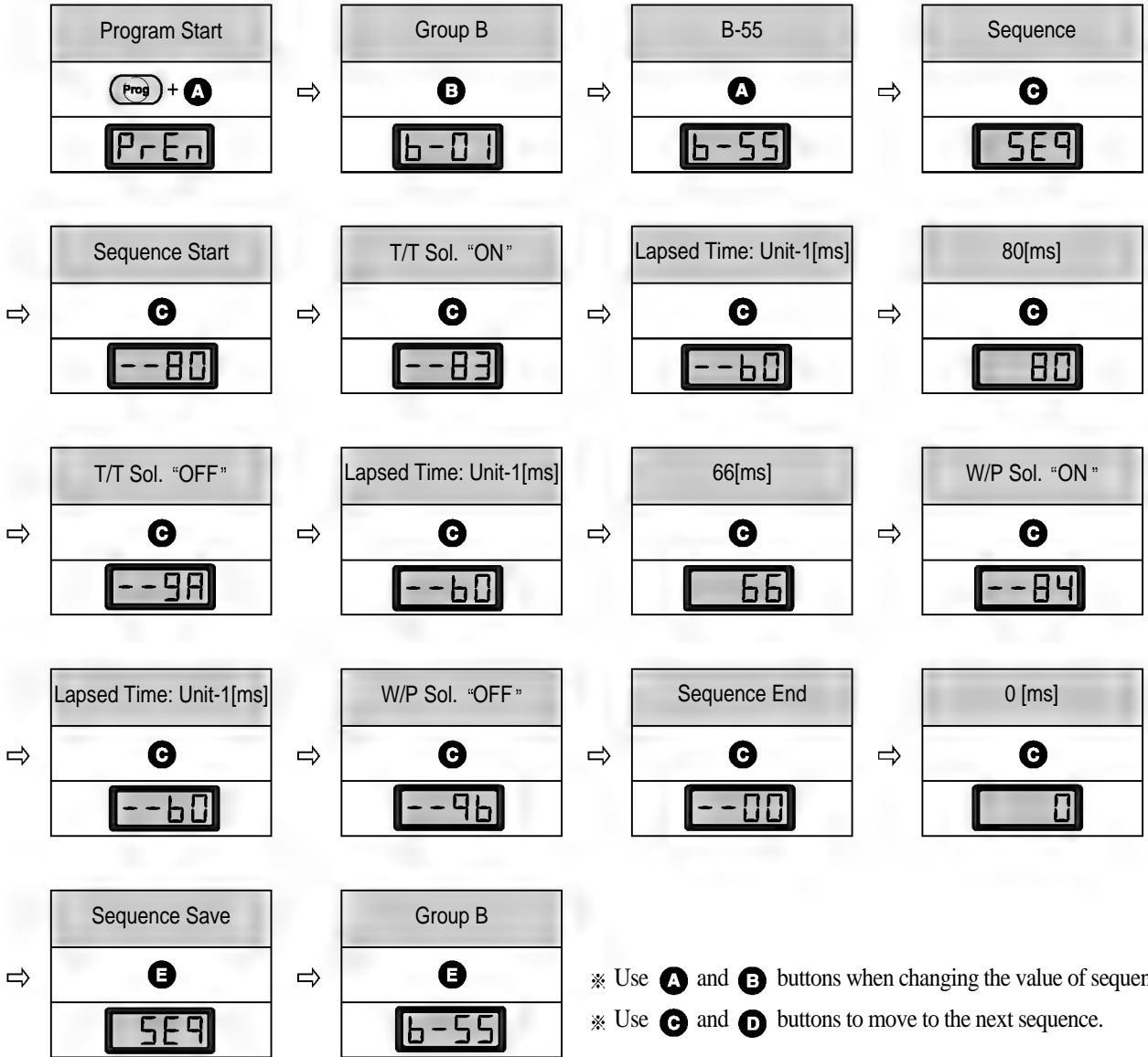

[Note]

When modifying the sequence by using the handy controller, the change in the sequence number is not displayed, so more care should be exercised in conducting the modification.

(3) Trimming Sequence of Chain-type Machine

When installing the controller which has an older program version, see the following and correct the trimming sequence.

Work Flow	Program Code																																																																																																						
<pre> graph TD Start([Start of Sequence]) --> TTON[T/T Solenoid "ON"] TTON --> Wait80[Wait for 80[ms]] Wait80 --> TTOFF[T/T Solenoid "OFF"] TTOFF --> Wait66[Wait for 66[ms]] Wait66 --> WPON[W/P Solenoid "ON"] WPON --> Wait1s[Wait for 1[s]] Wait1s --> WPOFF[W/P Solenoid "OFF"] WPOFF --> End([End of Sequence]) </pre>	<table border="1"> <thead> <tr> <th rowspan="2">Number</th> <th rowspan="2">Command</th> <th colspan="3">Data Part</th> <th rowspan="2">Explanation</th> </tr> <tr> <th>1st</th> <th>2nd</th> <th>3rd</th> </tr> </thead> <tbody> <tr> <td>01</td> <td>--80</td> <td></td> <td></td> <td></td> <td>Sequence Start</td> </tr> <tr> <td>02</td> <td>--83</td> <td></td> <td></td> <td></td> <td>T/T Solenoid "ON"</td> </tr> <tr> <td>03</td> <td>--B0</td> <td></td> <td></td> <td></td> <td rowspan="2">80[ms] of Time Lapse</td> </tr> <tr> <td>04</td> <td></td> <td>80</td> <td></td> <td></td> </tr> <tr> <td>05</td> <td>--9A</td> <td></td> <td></td> <td></td> <td>T/T Solenoid "OFF"</td> </tr> <tr> <td>06</td> <td>--B0</td> <td></td> <td></td> <td></td> <td rowspan="2">66[ms] of Time Lapse</td> </tr> <tr> <td>07</td> <td></td> <td>66</td> <td></td> <td></td> </tr> <tr> <td>08</td> <td>--84</td> <td></td> <td></td> <td></td> <td>W/P Solenoid "ON"</td> </tr> <tr> <td>09</td> <td>--B3</td> <td></td> <td></td> <td></td> <td rowspan="2">1[s] of Time Lapse</td> </tr> <tr> <td>10</td> <td></td> <td>10</td> <td></td> <td></td> </tr> <tr> <td>11</td> <td>--9B</td> <td></td> <td></td> <td></td> <td>W/P Solenoid "OFF"</td> </tr> <tr> <td>12</td> <td>--00</td> <td></td> <td></td> <td></td> <td>Trimming Sequence End</td> </tr> <tr> <td>.</td> <td></td> <td></td> <td></td> <td></td> <td></td> </tr> <tr> <td>.</td> <td>--00</td> <td></td> <td></td> <td></td> <td></td> </tr> <tr> <td>.</td> <td></td> <td></td> <td></td> <td></td> <td></td> </tr> <tr> <td>64</td> <td>--00</td> <td></td> <td></td> <td></td> <td>Sequence Close</td> </tr> </tbody> </table>	Number	Command	Data Part			Explanation	1st	2nd	3rd	01	--80				Sequence Start	02	--83				T/T Solenoid "ON"	03	--B0				80[ms] of Time Lapse	04		80			05	--9A				T/T Solenoid "OFF"	06	--B0				66[ms] of Time Lapse	07		66			08	--84				W/P Solenoid "ON"	09	--B3				1[s] of Time Lapse	10		10			11	--9B				W/P Solenoid "OFF"	12	--00				Trimming Sequence End	.						.	--00					.						64	--00				Sequence Close
Number	Command			Data Part				Explanation																																																																																															
		1st	2nd	3rd																																																																																																			
01	--80				Sequence Start																																																																																																		
02	--83				T/T Solenoid "ON"																																																																																																		
03	--B0				80[ms] of Time Lapse																																																																																																		
04		80																																																																																																					
05	--9A				T/T Solenoid "OFF"																																																																																																		
06	--B0				66[ms] of Time Lapse																																																																																																		
07		66																																																																																																					
08	--84				W/P Solenoid "ON"																																																																																																		
09	--B3				1[s] of Time Lapse																																																																																																		
10		10																																																																																																					
11	--9B				W/P Solenoid "OFF"																																																																																																		
12	--00				Trimming Sequence End																																																																																																		
.																																																																																																							
.	--00																																																																																																						
.																																																																																																							
64	--00				Sequence Close																																																																																																		
<p>[Note]</p> <p>⇒ When installing the top thread trimming device, change the trimming sequence value in No. 09 from B3 to B0 and the value in No. 10 to "0".</p> <p>⇒ If the program version is S-III("11") and S-IV("7") or above, set the value of A-73 at "1".</p>																																																																																																							

8) Use of KM-360J

(1) Set "100" at B-56

 <div style="border: 1px solid black; padding: 2px; width: fit-content; margin: 0 auto;">Caution</div>	<p>Make sure that the name of the control box type is "S4AC50-2JF36".</p>
--	---

(2) Setting hammer mode

- ① 1 With the setting value of No.37 in Group A, the hammer simultaneous working function can be set when you operate the presser foot (pedal reverse-1st phase) simultaneously during stitching.
 - (a) No.37, Group A: 0 the initial setting value
When the presser foot is working during stitching, the presser foot is operated only.
 - (b) No.37, Group A: 1
When the presser foot is working during stitching, the presser foot and the hammer are operated simultaneously.
- ② With the setting value of No.38 in Group A, hammer mode can be selected using knee switch.
 - (a) No.38, Group A: 0 the initial setting value
One Touch mode: A hammer is opened when you press the knee switch once and the hammer is closed when you press it again.
 - (b) No.38, Group A: 1
Push mode: A hammer is opened only during pressing the knee switch. When you take off the switch, the hammer is closed. (This is not working during stitching.)

③ Parameter

Parameter	Function	Initial Value	Range	Explanation
A-37	During the stop of stitching, when the 1st phase of pedal is moved backward(the presser foot increases), the presser foot and the hammer start working simultaneously En/Disable	0	0/1	0 : During the stop of stitching, when you press the reverse pedal(1st-phase), the presser foot is only working. 1 : During the stop of stitching, when you press the reverse pedal(1st-phase), the presser foot and the hammer are working simultaneously.
A-38	Select the hammer mode(One-Touch or Push mode) with using the bar switch.	0	0/1	0 : One-Touch mode (A hammer is opened when you press the bar switch once and the hammer is closed when you press it again.) 1 : Push mode (A hammer is opened only during pressing the knee switch. When you take off the switch, the hammer is closed.)

(3) Feature of the semi-automatic hammer mode (Set No.30 in Group A, operating when No.38 in Group is "0")

- ① When the setting value of No.30 in Group A is "0", (initial value)
 - (a) The hammer is working when pressing the knee switch and the hammer is closed the knee switch is repressed.
 - (b) The hammer is working below 1,000RPM during stitching.
- ② When the setting value of No.30 in Group A is "1", (semi-automatic motion)
 - (a) The hammer is working when pressing the knee switch and the hammer is closed the knee switch is repressed.
 - (b) When you keep your feet on the pedals under the hammer is working, the hammer is closed after stitching as much as the setting stitch and speed.
 - Setting speed : No. 31, Group A
 - Setting stitch : No. 34, Group A
 - (c) After closing the hammer, the stitching is available only when you keep your feet off the pedals and press again. (For prevent radical speed change)
 - Neutral mode of pedal check : No .85, Group A

③ Parameter related to the semi-automatic hammer mode

Group	Number	Function	Initial Value	Range
A	30	Hammer semi-automatic motion setting	0	0 : automatic 1 : semi-automatic
	31	Hammer semi-automatic motions, stitching speed	200	20-2000[rpm]
	34	Hammer semi-automatic motions, stitch length	5	0-255(stitch)
	85	Hammer semi-automatic motions, select the neutral mode of pedal check	1	0 : Function 1 : Function

9) Use of Detailed TPM(Total Production Maintenance) Functions

(1) Activating TPM Functions

Explanation	Remarks
① Use parameters F-01 ~ F-09 to set a desired TPM number at "1."	Users can selectively set desired TPMs only. Example) Set TPM 1, TPM 3 and TPM 5 only while the rests remain unused.
② Up to 9 can be simultaneously set.	When setting multiple TPMs, alarms for each TPM could be issued simultaneously.(see the code entry function)
③ Check if F-41 Parameter is set at "1."	F-41 is 0 : TPM is unused. F-41 is 1 : Among F-01~09, the TPM set at "1." only is activated.

(2) Time Setting



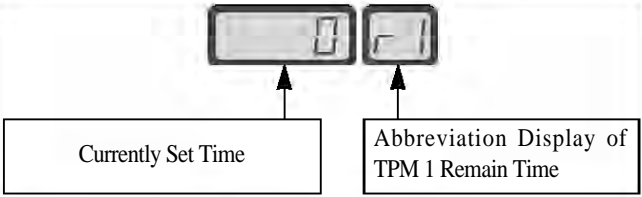
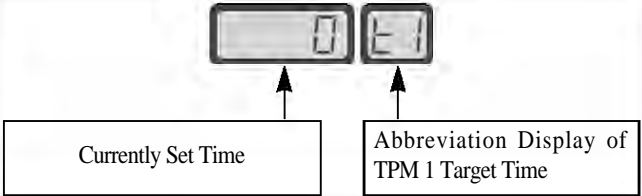
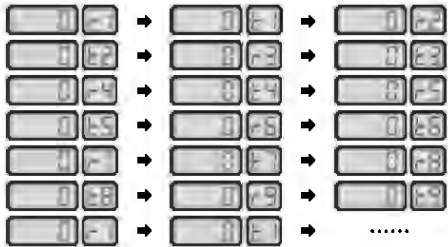





A. Use of hot keys

Explanation	Remarks
① When PROG button + COUNT button are pressed simultaneously, the screen displays "XXXX r1." (In the case of small-type PU, press the PROG button + ▼ button)	
② Press the E button, and the screen is changed to "XXXX r1."	
③ Continuous pressing of the E button moves up to next step. Pressing the F button moves to previous steps. (Able to check the currently set time and remain time)	<p>- When continuously pressing the "E" button</p>  <p>- When continuously pressing the "F" button</p>
④ During the moves across screens, pressing the C button increases the set value by one, while pressing the D button decreases the set value by one. (Unless Parameters F-1 ~ F-9 are set at 1(Enable), hot keys cannot be used to change target time and remain time.)	<p>[Caution]</p> <ul style="list-style-type: none"> - Changing the target time value automatically resets the remain time value to be same as the target time value. - After the target time value is changed, the screen displays the value before the change. However, after exiting the setup mode by pressing the PROG button and making re-entry, the changed value is displayed.











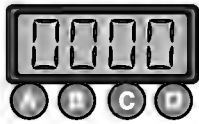

Unless Parameters F-1 ~ F-9 are set at 1(Enable), hot keys cannot be used to change target time and remain time.)

B. Use of Parameters

Explanation	Remarks
① With the  button pressed, turn on the power.	
② Press  +  button to move to Parameter Group F.	
③ Use the  (Up) and  (Dn) buttons to move to F-11 ~ 19.	
④ Set TPM time respectively at F-11 ~ 19.	

(3) Password Setting

Classification	Explanation	Remarks
① Password Setting	<ul style="list-style-type: none"> ■ Move to Parameter F-50 and the screen displays “0000”(initial password). ■ Use buttons A to D to change each digit of a password from 0 to 9. ■ Replace the initial password with the desired one and press the  button to save the setting. 	 <ul style="list-style-type: none">  Button : Set the first digit  Button : Set the second digit  Button : Set the third digit  Button : Set the fourth digit
② Enabling Password Function	<ul style="list-style-type: none"> ■ Set Parameter F-42 to decide enable/disable of a password function. ■ Set Parameter F-31~39 to enable a password function for TPM. 	When a password is unused and an alarm is issued, simply pressing “Enter” leads to the reset to default value and the alarm is stopped.
③ Features of Password Function	<ul style="list-style-type: none"> ■ When sewing is conducted after TPM setup, TPM alarm is issued in a certain time. ■ To stop alarming by pressing , the password function is enabled. (The screen shows “PASS ED” and then “0000”.) ■ If  is pressed after wrong password entry, short beep sound is issued three times and the screen stands by for password entry. <p>[Caution] In the case of using the password function, without proper password entry, the screen exit is not possible (The screen lock is not released even after power-off and power-on.)</p>	 Displaying an alarm issued for the first TPM time  Abbreviation of Password. “E” in Ed represents “W.”
④ Alarm Issuance	<ul style="list-style-type: none"> ■ When the TPM function is used, an alarm is issued in the set time. (Displayed as “CHEC XX.” “XX” represents concerned TPM number and is displayed as one among “0~9” indicating the checkup number subject to alarm.) ■ If multiple TPMs are set, over time, alarm timings could coincide to be same. In this case, the alarm of a lower number is issued first. After machine check and alarm release (Press “”), the alarm of next number is issued for checking out other parts of the machine. 	

(4) Detailed Description on Time Setting

Classification	Explanation
① Related Parameters	<ul style="list-style-type: none"> ■ F-43 : Setting the rated speed of a machine ■ F-44 : Applicable environmental variable when the set time is reduced ■ F-45 : Speed adjustment unit when adjusting time depending on current speed
② Detailed Description on F-43	<ul style="list-style-type: none"> ■ By comparing the current speed with the rated speed, a value is set to reflect time variables against the current speed. ■ If the current speed is higher than the rated speed, the remainder of the set time is reduced, and otherwise, the remainder of the set time is increased. ■ The remainder of the set time can be increased/decreased at the degree set in F-44~45.
③ Detailed Description on F-44	<ul style="list-style-type: none"> ■ When the remainder of the set time is reduced, the applicable environmental variable can be set at 1~20(0~50[%]). ■ The reduction ratio of a set time can be adjusted in reflection of current speed, temperature, and humidity.
④ Detailed Description on F-45	<ul style="list-style-type: none"> ■ The parameter takes into consideration the current speed vs the rated speed as part of the time reduction factors. ■ The parameter sets the speed range.
⑤ Example	<ul style="list-style-type: none"> ■ F-43 : Set 3000[spm] (rated speed) ■ F-45 : Set 400[spm] (When adjusting time in line with the current speed, this is the speed adjustment unit) ■ Current user speed: 2500[spm] ■ Result Between 3000 ~ 2600[spm] (Step 1 for extending the speed reduction time) and 2600 ~ 2300 (Step 2 for extending the speed reduction time), the current speed belongs to Step 2 so that the concerned amount of speed reduction time will be extended.

	<ol style="list-style-type: none"> 1. Due to the environmental factors as stated above, actually an alarm is issued not at the set time but according to the value considered at F-43/44/45. 2. Unless special change is made, F-43/44/45 is set at default values, and their values are reduced at a certain reduction ratio. In the event that mismatch between the actual checkout time and the alarming time occurs, the set time can be adjusted.
---	--

SIMPLE OPERATION UNIT PART NAMES AND METHOD OF USE

1) Names of Each Part in the Simple Operation Unit

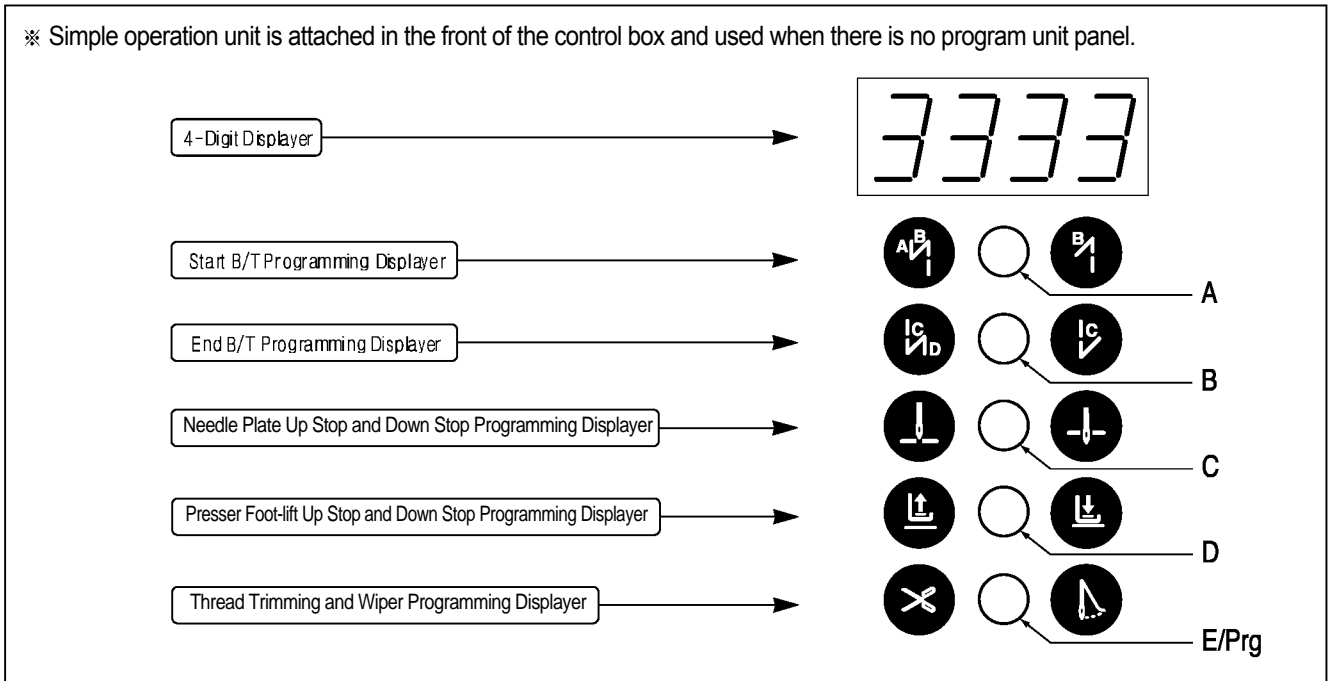

2) Simple Program Unit Method of Use

(1) Initializing

This function is used when the user randomly corrects the programmed value and forgets the initial programmed value.

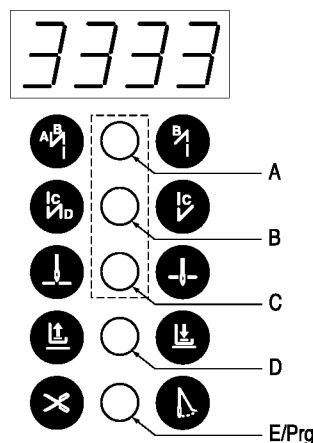





Turn the power on by simultaneously pressing the buttons , A and B, C.

[Caution]

- When you initialize, you change all the original values that the sewing machine had when it was manufactured in the factory. Initialize only when absolutely necessary.
- When initializing, you must run the motor for more than 5 seconds at the speed of 1000RPM in order to make the synchronizer to work properly.





(2) Programming the Start B/T Sewing Conditions with Button A

This button is used when the user wants to prevent threads from loosening at the end of the sewing work. If the user presses this button in sequence, the location on the lights will change as shown in the figures below. This button offers the following three functions.

 <p>When sewing starts, B/T sewing does not operate.</p>	 <p>When sewing starts, B/T sewing can be done with the  button.</p>	 <p>When sewing starts, B/T sewing can be done with the  button.</p>
<p>Use the A, B button to program the number of B/T stitches in the 4-digit displayer.</p>		
<p>[Caution] Be aware that if the end B/T stitch number is set to '0' in the 4-digit displayer, the user will be unable to operate start B/T sewing.</p>		





(3) Programming the Start B/T Sewing Conditions with Button B

This button is used when the user wants to prevent threads from loosening at the end of the sewing work. If the user presses this button in sequence, the location on the lights will change as shown in the figures below. This button offers the following three functions.



 <p>When sewing starts, B/T sewing does not operate.</p>	 <p>When sewing starts, B/T sewing can be operated with the  button.</p>	 <p>When sewing starts, B/T sewing can be operated with the  button.</p>
<p>Use the C, D button to program the number of B/T stitches in the 4-digit displayer.</p>		
<p>[Caution] Be aware that if the end B/T stitch number is set to '0' in the 4-digit displayer, the user will be unable to carry out start B/T sewing.</p>		

(4) Programming the Needle Plate Position when Sewing Stops with Button C



When you turn the power on, one of needle plate's up stop and down stop lights in the simple operation unit will always be on. If you press the button you can select the stopping location.

 <p>If the machine stops while sewing, the needle plate makes an up stop.</p> 	 <p>If the machine stops while sewing, the needle plate makes a down stop.</p> 
--	--



(5) Programming the Presser Foot-lift Location when Sewing Stops with the Button D

<p>When you turn the power on, one of presser foot-lift's up stop and down stop lights in the simple operation unit will always be on. If you press the button you can select the stopping location.</p>	
 <p>If the machine stops while sewing, the presser foot-lift makes an up stop.</p>	 <p>If the machine stops while sewing, the presser foot-lift makes a down stop.</p>

(6) Programming the Automatic Thread Trimmer and Wiper Movements with the Button E/Pro

<p>This button programs the automatic trimmer and wiper after sewing. If the user presses this button in sequence, the location on the lights will change as shown in the figures below. This button offers the following three functions.</p>		
 <p>Automatic trimmer and wiper are not operating.</p>	 <p>Only the automatic trimmer is operating</p>	 <p>Both the automatic trimmer and wiper are operating</p>

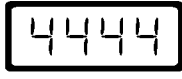

(7) Programming the Start and End B/T Stitches

<p>① Press the appropriate button for 0.5 seconds for the place you wish to program the new B/T stitch value. The light will blink in that place.</p> <ul style="list-style-type: none"> • Programming buttons for number of start B/T stitches : buttons A, B • Programming buttons for number of end B/T stitches : buttons C, D 	<p><Initial Screen></p> 
<p>② If the number is blinking, you can change the programmed value by pressing the appropriate button. (Ex : If you press the A button for 0.5 seconds, the first number in the screen will blink).</p>	<p><When the button A has been pressed for 0.5 seconds></p> 
<p>③ If programming is completed, press the same button for 0.5 seconds once more and you will return to the initial screen. (Ex : Changing the value of A, B, C, D from 3, 3, 3, 3 to 4, 4, 4, 4)</p>	
<p>[Caution] Be aware that if you don't press the button for 0.5 seconds, the screen will not return to the B/T stitch programming screen but will remain in the sewing conditions program change (items 1~4 functions) section.</p>	

(8) Sewing Speed and Rotating Direction Programming Method

<p>① If you press the E/Prg button for 0.5 seconds, you will see the screen that enables you to change the sewing speed. If you press the same button again for 0.5 seconds, you will see the screen that enables you to change the rotating direction. If you press the button one more time, you will return to the initial screen. (Initial screen → Speed programming screen → Rotating direction programming screen → Initial screen)</p>	
<p>② If you want to change the sewing speed, press the E/Prg button. After seeing the speed programming screen, press buttons A and B to program the speed you want.</p>	
<p>[Caution] Be aware that if you don't press the button for 0.5 seconds, the screen will not return to the B/T programming screen but will remain in the sewing conditions programming screen (Items 1~4 functions).</p>	

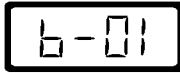
(9) Method to Change Parameter Specific Items



<p>① To change the parameter's detailed items, press the E/Prg and A buttons simultaneously and return to the parameter detailed item's initial screen.</p>	<p><parameter specific item initial screen></p>
<p>② If you see the "PrEn" screen, select a parameter group using buttons A~D.</p> <ul style="list-style-type: none"> • A button : A group, B button : B group • C button : C group, D button : D group 	<p><Initial screen for group A> <Initial screen for group B></p>   <p><Initial screen for group C> <Initial screen for group D></p>  
<p>③ After selecting the group you want, use buttons A and B to select the specific item you want.</p> <ul style="list-style-type: none"> • Ex: Select No. 2 item of Group A (Limiting the maximum sewing speed) 	
<p>④ If you selected the specific item you wanted, press button C. The value you selected will then appear on the screen.</p> <ul style="list-style-type: none"> • Ex : The current maximum sewing speed 4000RPM. 	
<p>⑤ Using the buttons A and B, change the current programmed value to another value.</p> <ul style="list-style-type: none"> • Ex : Change the maximum sewing speed from 4000RPM to → 3000RPM 	
<p>⑥ If you completed your selection, press the C to save the value you chose.</p>	

<p>⑦ You can change other specific items of the parameter in the same manner.</p>	
<p>[Caution]</p> <ul style="list-style-type: none"> • Be aware that if you changed the specific items of the parameter and didn't press the C button, the changed value will not be saved. • If you change the parameter specific items carelessly, this may cause breakdown or physical damage to the machine. Therefore, the user must be well-trained before changing items in the parameter group. 	

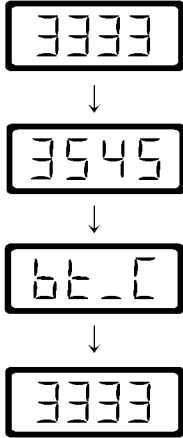
(10) Start and End B/T Stitch Number Correction Method

<p>① Corrections in the initial screen are the same as those in item (13) of the program unit manual "Correcting method for when the B/T number differs by one stitch"</p> <ol style="list-style-type: none"> Check the present sewing condition. Change the value of the part that needs correction (use A, B, C, D buttons) Save the programmed value (press the E/Prg and B buttons simultaneously). <p>→ You will go to the "bt-C" screen. The buzzer will sound three times and you will return to the initial screen</p>	
<p>② When making corrections of less than one stitch use items 30~33 of parameter Group B and will correct to stage 0.05.</p>	
<p>※ For detailed B/T stitch number correction method, refer to the section (13) of the Program Unit manual.</p>	

(11) Method of Use of the Inertia Tuning Function

<p>① The inertia tuning function is to find the motor's gain value that match the weights inertia. Press buttons E/Prg and D simultaneously to return to the initial screen of the inertia tuning.</p>	<p><Inertia tuning initial screen></p> 
<p>② If the initial screen comes on, press the pedal until you hear the buzzer ring. (During inertia tuning the sewing machine will operate and stop 10 times).</p>	<p><Initial screen></p> 
<p>③ If the inertia tuning is completed, the buzzer will ring and the initial screen will come on at the same time.</p>	
<p>[Caution] Inertia tuning is carried out only when the controller is attached to the sewing machine for the first time and when the sewing machine is unable to accelerate or decelerate quickly.</p>	

FORTUNA SERIES 4 FULL FUNCTION SOFTWARE METHOD OF USE

1) Basic Functions of the Fortuna Series 4 Full Function Software

(1) Initializing

This function is used when the user randomly changes the parameter's programmed value, and forgets the original program contents.

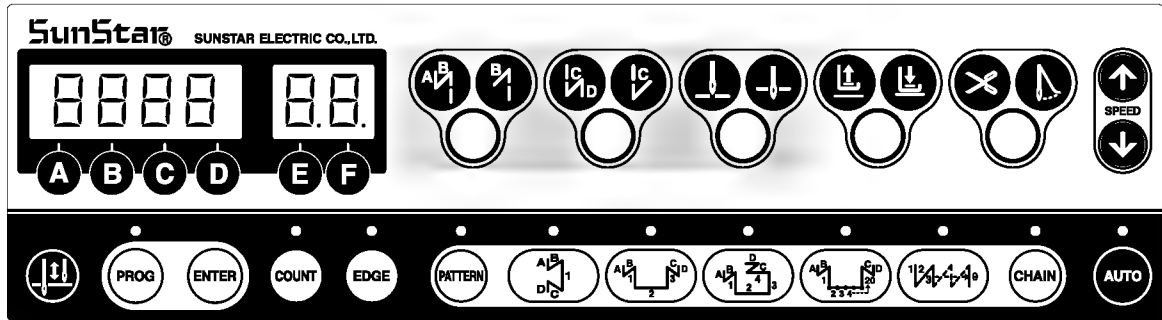

Method of initializing: Turn the power on by simultaneously pressing the buttons in the figure above which are the start B/T button + end B/T button + needle plate up/down stop button.

[Caution]

- If you initialize, all the changes made by the user are changed to the original values programmed when the machine was delivered from the factory, therefore only change the value if absolutely necessary.
- After initializing, rotate the machine for 1000RPM or more for approximately 5 seconds. You must make the machine remember the location of the FILM.

(2) Sewing Machine Up/Down Stop Location Automatic Recalling Function

When first purchasing the controller, if the user steps on the pedal for 5 seconds and runs the motor before beginning the sewing work, the machine will automatically remember the sewing machine's up/down stop location. However, when using a synchronizer this step is not necessary.

(3) Method of Use and Functions of the Program Unit and the General Control Box's Simple Operation Box.

When there is a program unit(P/U), use it to program or change all the functions of the machine. When there is no program unit, use the general control box operation panel to program or change all the functions of the machine.

※ For detailed information on the method of use of program units and simple operation panel refer to the explanation in the last section.



(4) Function Parameter

Parameter group	Functions
① Group A	General functions of the sewing machine
② Group B	All types of output, Full-on Time/PWM Duty, checking input/output operations, sewing machine models and thread trimming sequence programming
③ Group C	Pedal acceleration/deceleration curve, slow starting speed and input/output port change related parameters
④ Group D	All types of gain parameter related motor control
⑤ Group F	TPM(Total Production Maintenance)-related Parameters

※ If the specific items of the parameter are changed carelessly, they could cause breakdown or damage the machine. Therefore the user must be well-trained before using it.

2) Fortuna Series 4 Full Function Software Specific Parameters

(1) Group A Parameter: General functions of sewing machine

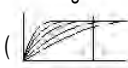
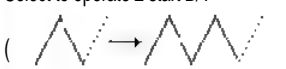
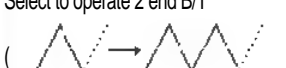
No.	Function	Initial value	Range	Step
1	Minimum speed of pedal (limit of sewing machine's minimum speed)	200spm	20-510	2spm
2	Maximum speed of pedal (limit of sewing machine's maximum speed)	4000spm	40-9960	40spm
3	Thread trimmer speed (Sewing machine speed from beginning to end of thread trimming when using CAM type)	300spm	20-510	2spm
4	Program Unit + 1 stitch speed ( Key's performance speed)	100spm	20-510	2spm
5	Lifting of needle plate with button A, dropping speed ( 's performance speed)	300spm	20-510	2spm
6	Pedal degree of acceleration (Pedal Curve) ( ;When the maximum speed is put in 255 steps)	255	1-255	1
7	Start Back-Tack Speed	1700spm	20-2000	10spm
8	End Back-Tack Speed	1700spm	20-2000	10spm
9	Thread trimming operation time (The A24 used in PNEUMATIC = must be 1) (The Solenoid operation time)	100ms	4-1020	(When doing an aging test, the value is equal to the running time)
10	Tension release operation time (The A24 used in PNEUMATIC = must be 1)	200ms	4-1020	(When doing an aging test, the value is equal to the thread trimming time)
11	Tension release time (In CAM type, the used A24 = must be 0) (In CAM type, the tension release is the value of the moving CAM angle)	255	0-255	
12	Waiting time for the next operation after thread trimming (This is the delaying time to carry out the next operation after thread trimming is finished)	4ms	4-1020	
13	Wiper operation time (Wiper Solenoid operating time)	48ms	4-1020	4ms
14	Waiting time after wiper operation (presser foot-lift etc.)	40ms	4-1020	4ms
15	Automatic presser foot-lift delaying time	100ms	4-1020	4ms
16	Automatic presser foot- lift maintaining time (After programmed time the presser foot-lift is automatically released) Automatic presser foot-lift drop waiting time for next operation	300 × 0.1sec	5-1000	0.5sec
17	(The delaying time, or the time that the foot-presser lift is maintained, the pedal is started until the presser foot-lift drops and the sewing machine is started)	100ms	4-1020	4ms
18	Selection for automatic foot-presser lift after thread trimming	0	0/1	1=lift selection 0=2step backward thread trimming
19	Selection for pedal thread trimming position	0	0/1/2	1=1 step backward thread trimming 2=thread trimming at neutral position
20	The maximum sewing speed for the KM-1060BL-7 presser foot-lift with mutual crossing quantity of 4.8-7.0[mm]	2000spm	200-2000	10spm
21	Delaying time for complete release of KM-1060BL-7 B/T Solenoid	200ms	4-1020ms	4ms
22	Select to operate 2 start B/T ()	0	0/1	Choose between 1 or 2
23	Select to operate 2 end B/T ()	0	0/1	Choose between 1 or 2
24	Selection of thread trimming conditions (selection according to sewing machine type)	0	0/1/2	0=CAM type machine 1= thread trimming after up-stop 2=thread trimming after low-stop
25	Whether or not to use default sequence when A24 = 1 (This is a sequence determined on A9,A10 value)	0	0/1	0=B-55 exclusive sequence is used 1= default sequence is used
26	Selection of B/T Solenoid operation position	0	0/1	0= lower position 1= upper position



Caution

If the specific items of the parameter are changed carelessly, they could break down or damage the machine, so the user must be well-trained before using it.

No.	Function	Initial value	Range	Step
27	Setting the maximum sewing speed of the machine according to presser foot-lift height of the KM-1060BL sewing machine.	?	?	Less than P1xx:3500[spm] Less than P2xx:3000[spm] Less than P3xx:2500[spm] More than P3xx: A20[spm] program P1xx → P2xx → P3xx in order
28	Needle bar's automatic stop at the highest position	0	0/1	
29	Pedal analog filtering difference	10	1-30	1
30	When using an angle 2-needle, select the semi-automatic corner operation	0	0/1	0 : Automatic 1 : Semi-automatic
	[For KM-360J] Setting automatic/semi-automatic motions for hammer & sub-presser foot	0	0/1	
31	Speed when selecting a semi-automatic corner (parameter used only when used after selecting number 30)	200spm	20~2000	10spm
	[For KM-360J] Sewing speed during semi-automatic operation (parameter used only when used after selecting number 30)			
32	After selecting the left needle the first sewing stitch (parameter used only when used after selecting number 30)	3 stitches	0~255	1 stitch
33	After selecting the left needle the second sewing stitch (parameter used only when used after selecting number 30)	3 stitches	0~255	1 stitch
34	After selecting the right needle the first sewing stitch (parameter used only when used after selecting number 30)	3 stitches	0~255	1 stitch
	[For KM-360J] Sewing stitch count during semi-automatic operation	5 stitches	0~255	1 stitch
35	After selecting the right needle the second sewing stitch (parameter used only when used after selecting number 30)	3 stitches	0~255	1 stitch
36	Maintaining time for the left/right needle solenoid (After the programmed time the solenoid is automatically released)	450 × 0.1sec	(50~1000)	0.5sec
37	[For KM-360J] Select the hammer open maintenance using the knee switch	1	0/1	0 : Not used 1 : Used
38	[For KM-360J] Select the hammer open maintenance using the pedal	0	0/1	0 : Not used, 1 : Used
39	Stopping function during AUTO mode and while pedal is neutral	1	0/1	0=does not stop 1=stops
40	Selection of type of N-stitch Sensor	0	0 : active high	1 : active low
41	The number of stitches done after the N-stitch Sensor has finished sensing. (After sensing, it will sew the programmed number of stitches and stop)	3 stitches	0~255	1 stitch
42	N-stitch sewing speed	1000spm	20~2000	10spm
43	Selection of One Touch function (Used in the sewing mode that uses the auto function)	0	0/1	1=Auto Mode
44	Selection of One Touch function (If there is no thread trimming signal when selected, sewing will continue even if user releases pedal)	0	0/1	1=One-Shot Mode
45	One-Shot sewing speed	2000spm	40~9960	40spm
46	N-stitch sewing mode selection → a sewing mode that inputs a sensor signal in the edge sensor port and uses it as an edge sensor	0	0/1	1=N-stitch Mode
47	Selection of pre-stitch function (When selected it will perform only the programmed stitches before the actual sewing work starts)	0	0/1	1=selection
48	Pre-stitch number of stitches	3 stitches	0~255	1 stitch
49	Pre-stitch speed	2000spm	20~2000	10spm
50	Selection of start B/T operating conditions (0 : if pedal is released during back tack, it will stop) (1 : if pedal is released during back tack, the work will still be completed) (2 : it will perform the exact amount of back tack stitches)	1	0 : B/T stop function selected 1 : B/T work completion 2 : B/T exact stitch performance	
51	Selection of end back tack performance condition (It will perform the exact amount of stitches for end back tack)	0	0/1	1= exact stitch performance

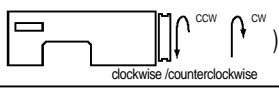

If the specific items of the parameter are changed carelessly, they could break down or damage the machine, so the user must be well-trained before using it.

No.	Function	Initial value	Range	Step
52	Back tack initial first stitch speed during back tack exact performance	200spm	20~1000	10spm
53	Change between B/T and switch with buttons A or B during sewing	0	0/1	1= Select with button B
54	Selection of button A function	2		0 : Only B/T operates 1 : Lift and drop needle plate with one movement. 2 : Lift needle plate with one movement. Drop needle plate with two movements 3 : Slow performance when stopped (1/2 stitch speed)
55	Selection of Button B function	0		0 : B/T delete insertion 1 : Lift and drop needle plate with one movement 2 : Slow performance when stopped (1/2 stitch speed) 3 : Only B/T operates
56	Selection of speed during manual back tack during sewing	0	0/1	0 : current sewing speed 1: initial reverse speed
57	NOT USED	-	-	-
58	Thread Trimming Sequence Selection of SunStar Chain Stitch Machine	1	0/1	1
59	Thread Trimming Sequence Selection of other Company chain Stitch Machine	0	0/1	1
60	Selection of reverse rotation after trimming	0	0/1	1:selection of reverse direction
61	Reverse rotation distance when selecting reverse rotation after thread trimming	20degree	0~250	1degree
62	When machine stops fix pulley (When machine stops fix the motor by force)	0	0/1	1: fix when machine stops
63	Power to fix the A number 62 Pulley	40	10~100	1
64	Distance recovered after fixing A number 62 Pulley and rotating it by force	20degree	10~100	1degree
65	Select the motor rotating direction ()	1	0/1	1 : clockwise 0 : counterclockwise
66	Target speed : If this speed is reached or passed, a signal saying "Target speed has been reached" will appear.	1000spm	40~9960	40spm
67	Delay start setup	0	0/1	0=normal start 1=Delay start
68	Delay start time duration setup	3	3~250	1 × 100[ms]
69	Setup of needle bar's stop at the lowest position after trimming when the pedal is pressed	0	0/1	0=disabled 1=enabled
70	Setup of the duration of needle bar's stop at the lowest position after trimming when the pedal pressed	100	100~250	1[ms]
71	Fixing of edge sensor	0	0/1	0=disabled 1=enabled
72	Detection time of high-voltage error	10	2 ~ 1020[ms]	2 [ms]
73	Use of the upper trimming device	0	0/1	0=disabled 1=enabled
74	Hammering function	0	0/1	0=disabled 1=enabled
75	NOT USED	-	-	-
76	NOT USED	-	-	-
77	NOT USED	-	-	-
78	Start Backtack On Duration	4[ms]	4~1020[ms]	4[ms] (Parameter run when the backtack accuracy function is used)
79	Start Backtack Off Duration	4[ms]	4~1020[ms]	
80	End Backtack On Duration	4[ms]	4~1020[ms]	
81	End Backtack OFF Duration	100[ms]	4~1020[ms]	

 **Caution** If the specific items of the parameter are changed carelessly, they could break down or damage the machine, so the user must be well-trained before using it.

No.	Function	Initial value	Range	Step
82	Stitch width reduction during backtacking	0	0/1	0=disabled 1=enabled
83	Sewing speed screen display	0	0/1	0=disabled 1=enabled
84	Not Used	-	-	-
85	[KM-360] Temporary suspension during semi-automatic operation	1		0 : After temporary suspension, the motion of pressing, releasing and pressing again the pedal resumes operation. 1 : Sewing begins without suspension.
86	[KM-360] Setting the hammer device action switch (knee switch) function	0		0 : when the knee switch is working, the hammer is moved 1: when the knee switch is working, the hammer and the presser foot start moving simultaneously.
87	Not Used	-	-	-
88	The presser foot and the left/right needle solenoid ascend automatically. Enable/Disable the solenoid OFF function	1		10 : Enable(in the event of using an electronic solenoid) 1 : Enable(in the event of using a pneumatic solenoid)
89	Upon trimming for a chain-type model, enable/disable the needle auto lift.	1	0/1	0=disabled 1=enabled



Caution

If the specific items of the parameter are changed carelessly, they could break down or damage the machine, so the user must be well-trained before using it.



(2) Group B Parameter : All types of output, Full-on Time/PWM Duty, checking input/output operations, sewing machine models and thread trimming sequence programming.

※ These are functions not used by general users and must be regulated by an A/S technician.

No.	Function	Initial value	Range	Step
1	Back Tack Solenoid Initial Full On Time	1020ms	4~1020	4ms
2	Presser Foot-Lift Solenoid Initial Full On Time	200ms	4~1020	4ms
3	T/T Solenoid Initial Full On Time	100ms	4~1020	4ms
4	Wiper Solenoid Initial Full On Time	100ms	4~1020	4ms
5	Tension Release Solenoid Initial Full On Time	100ms	4~1020	4ms
6	Left Solenoid Initial Full On Time (For Twin Needle)	100ms	4~1020	4ms
7	Right Solenoid Initial Full On Time (For Twin Needle)	100ms	4~1020	4ms
8	Auxiliary Solenoid Initial Full On Time	100ms	4~1020	4ms
9	Left LED Initial Full On Time (For Twin Needle)	100ms	4~1020	4ms
10	Right LED Initial Full On Time (For Twin Needle)	100ms	4~1020	4ms
11	Needle plate up-stop signal Initial Full On Time	100ms	4~1020	4ms
12	Needle plate down-stop signal Initial Full On Time	100ms	4~1020	4ms
13	Signal notifying motor running Full On Time	100ms	4~1020	4ms
14	Signal notifying target speed achieved Full On Time	100ms	4~1020	4ms
15	Back Tack Solenoid Duty Ratio	50%	0~100	10%
16	Presser Foot-Lift Solenoid Duty Ratio	20%	0~100	10
17	Thread Trimming Solenoid Duty Ratio	100	0~100	10
18	Wiper Solenoid Duty Ratio	100	0~100	10
19	Tension Release Solenoid Duty Ratio	100	0~100	10
20	Left Solenoid Duty Ratio (For Twin Needle)	50	0~100	10
21	Right Solenoid Duty Ratio (For Twin Needle)	50	0~100	10
22	Aux Solenoid Duty Ratio	100	0~100	10
23	Left LED Duty Ratio (For Twin Needle)	100	0~100	10
24	Right LED Duty Ratio (For Twin Needle)	100	0~100	10
25	Signal for up stopping needle Duty Ratio	100	0~100	10
26	Signal for low stopping needle Duty Ratio	100	0~100	10
27	Signal notifying motor running Duty Ratio	100	0~100	10
28	Signal notifying target speed reached Duty Ratio	100	0~100	10
29	NOT USED			
30	Start Back Tack A number of stitches correction value	00.30	6~6	0.05 Stitch
31	Start Back Tack B number of stitches correction value	00.30	6~6	0.05 Stitch
32	End Back Tack C stitch correction value	00.40	6~6	0.05 Stitch
33	End Back Tack D stitch correction value	00.40	6~6	0.05 Stitch
34	Selection for maintaining reverse solenoid movement when thread trimming (C Only B/T)	0	0/1	1=reverse direction maintained
35	Programming count condition (program whether or not automatic counter will be operated)	0	0/1	0=counter used 1=automatic counter after thread trimming
36	When automatically counting, select Up/Down count after thread trimming (thread trimming function must be enabled)	1	0/1	1=Up COUNT 0=DOWN COUNT
37	When count in completed, the next operation is programmed	0	0/1/2	0=buzzer rings, sewing is allowed 1=buzzer rings, sewing is not allowed (If you press the Prog Key, set up is cancelled) 2=No buzzer ring, sewing is allowed
38	When count is completed, select the counter auto clear/preset	0	0/1	1=AUTO CLEAR/PRESET
39	Bobbin counter set-up	0	0/1	0=Bobbin counter Disable 1=Bobbin counter Enable

※ Items No. 30~33 : These are the items that make the number of stitches match when back tack number of stitches do not match.

※ Solenoid Duty Ratio : The power that holds and maintains the solenoid.

Solenoid initial full on time : The time it takes to pull the solenoid to the maximum in the outset.

[Caution]

If the specific items of the parameter are changed carelessly, they could break down or damage the machine, so the user must be well-trained before using it.

No.	Function	Initial value	Range	Step
40	Checks operation of B/T solenoid (OUTPUT00)	※ Match the number of the solenoid to be tested then press the "+1 stitch ()" key of P/U(button A in case of simplified manipulation) and check the state. - Along with the output, it will say "on", or "off"		
41	Checks operation of P/F solenoid (OUTPUT01)			
42	Checks operation of T/T solenoid (OUTPUT02)			
43	Checks operation of W/P solenoid (OUTPUT03)			
44	Checks operation of T/R solenoid (OUTPUT04)			
45	Checks operation of left solenoid (OUTPUT05)			
46	Checks operation of right solenoid (OUTPUT06)			
47	Checks operation of Aux. solenoid (OUTPUT07)			
48	Checks operation of Left LED solenoid (OUTPUT10)			
49	Checks operation of Right LED solenoid (OUTPUT11)			
50	Checks operation of needle when signal notifies up stop (OUTPUT12)			
51	Checks operation of needle when signal notifies down stop (OUTPUT13)			
52	Checks operation of signal notifying motor running (OUTPUT14)			
53	Checks operation signal notifying target speed has been reached (OUTPUT15)			
54	Select [Thread trimming sequence] - The default is set to '0'. If you wish to input another sequence apart from the thread trimming sequence provided in the system input the newly composed sequence number. (Refer to the sequence composition method)	0	0~64	1
55	Thread trimming sequence data writing function			
56	Selecting sewing machine model - write the number that fits the sewing machine model provided in the full function manual.. - thread trimming sequence in the pertinent machine is copied. - if you want to correct the thread trimming sequence, change the contents of item B-55. (※ However, be aware that if you initialize the parameter, the newly programmed changes will disappear and the thread trimming sequence will change to that of [SunStar 235/250]).	0	0~127	1 0~ 74 (non-order made) 75~118 (order-made) (Refer to attached material)
57	Independent operation of trimming sequence	0	0/1	0=operation after trimming 1=independent operation
58	Presser foot-lift solenoid slowing down time #1 (Applied only when it is full-on condition)	40ms	2~510ms	2ms
59	Presser foot-lift solenoid slowing down time #2 (Applied only when it is PWM)	30ms	2~510ms	2ms

※ Items No. 40~53 : functions that check if solenoid and other output signals are working properly.

※ Select Item No. 55 and press the Enter key. Along with the buzzer sound you will see the words "Seq 55" appear on the screen. Thread trimming sequence composition permitting condition is now possible. You can program a thread trimming sequence to a maximum of 64 bytes. (For thread trimming sequence program method, refer to attached material).

[Caution]

If the specific items of the parameter are changed carelessly, they could break down or damage the machine, so the user must be well-trained before using it.

No.	Function	Initial value	Range	Step
60	Checks the signal input INPUT00 (Button A)			
61	Checks the signal input INPUT01 (Button B)			
62	Checks the signal input INPUT02 (1/4 stitch Switch)			
63	Checks the signal input INPUT03 (2/4 stitch Switch)			
64	Checks the signal input INPUT04 (3/4 stitch Switch)			
65	Checks the signal input INPUT05 (4/4 stitch Switch)			
66	Checks the signal input INPUT06 (Left Switch)			
67	Checks the signal input INPUT07 (Right Switch)			
68	Checks the signal input INPUT10 (Manual presser foot-lift Switch)			
69	Checks the signal input INPUT11 (Counter Switch)			
70	Checks the signal input INPUT12 (PU 1/2 stitch Button)			
71	Checks the signal input INPUT13 (Safety Switch)			
72	Checks the signal input INPUT14 (Edge Sensor)			
73	Checks the signal input INPUT15 (Thread trimming not allowed)			
74	Checks the signal input INPUT20 (First step for pedal going forward)			
75	Checks the signal input INPUT21 (First step for pedal going backwards)			
76	Checks the signal input INPUT22 (Second step for pedal going backwards)			
77	Checks the solenoid movement voltage		0~64	
78	Checks external volume value		0~64	
79	Checks the pedal analog output		0~64	
80	Checks the synchronizer signal			Increases by each rotation of the sewing machine
81	Checks the signal from encoder A/B			1) increases when sewing machine rotates clockwise 2) decreases when sewing machine rotates in counterclockwise
82	Checks the signal from encoder R/S/T			1) When sewing machine is rotating clockwise 101 100 110 010 011 001 101 2) When sewing machine is rotating counterclockwise 101 001 011 010 110 100 101
83~	NOT USED			
89	NOT USED			

Along with the input, it will say "on" or "off"

- ※ Items No. 60~76: functions that check individual normal movement.
- ※ Items No. 77~79 : functions that check each analog input normal movement.
- ※ Item No. 80 : function that checks whether the synchronizer signal is working properly.
- ※ Item No. 81 : function that checks whether the encoder A/B is working properly.
- ※ Item No. 82 : function that checks whether the encoder R/S/T is working properly.

[Caution]

If the specific items of the parameter are changed carelessly, they could break down or damage the machine, so the user must be well-trained before using it.

No.	Function	Initial value	Range	Step
90	Sewing machine pulley size	?	0~9999	1pulse
91	Distance between up-stop ~ low-stop (the standard is the pulley's normal direction rotation)	?	0~9999	1pulse
92	Programming the upper stop location (the standard is the pulley's normal direction rotation) - Not valid for model S-III	?	0~359	1degree
93	Programming the low-stop location (the standard is the pulley's normal direction rotation) - Not valid for model S-III	?	0~359	1degree
94	Index pulse occurring position (the standard is the pulley's normal direction rotation) - Turn the pulley manually and stop it in the position you want.	?	0~359	1degree
95	CAM type thread release solenoid operation position - Turn the pulley manually and stop it in the position you want.	?	0~359	1degree
96	CAM type thread release solenoid release position - Turn the pulley manually and stop it in the position you want.	?	0~359	1degree
97	CAM type thread trimming solenoid operation position - Turn the pulley manually and stop it in the position you want.	?	0~359	1degree
98	CAM type thread trimming solenoid release position - Turn the pulley manually and stop it in the position the user wants	?	0~359	1degree
99	Manual and automatic set up of solenoid operation / release position in CAM type thread trimming	1	0/1	0=manual set up 1=automatic set up

[Caution]

If the specific items of the parameter are changed carelessly, they could break down or damage the machine, so the user must be well-trained before using it.

(3) Group C Parameter: Pedal acceleration/deceleration curve, slow starting speed and input/output port change related parameter

※ These are functions not used by general users and must be regulated by an after-sales service engineer.

No.	Function	Initial value	Range	Step
1	1 step section where pedal moves forward	17	0~64	1
2	2 step section where pedal moves forward	22	0~64	1
3	3 step section where pedal moves forward	38	0~64	1
4	4 step section where pedal moves forward	47	0~64	1
5	5 step section where pedal moves forward	59	0~64	1
6	Sewing speed value in the 1 step where pedal moves forward	440spm	40~9960	40spm
7	Sewing speed value in the 2 step where pedal moves forward	920spm	40~9960	40spm
8	Sewing speed value in the 3 step where pedal moves forward	4000spm	40~9960	40spm
9	Sewing speed value in the 4 step where pedal moves forward	5480spm	40~9960	40spm
10	Sewing speed value in the 5 step where pedal moves forward	9960spm	40~9960	40spm
11	Select slow start after thread trimming (After performing thread trimming, start the next sewing work slowly)	0	0/1	1=selection
12	Select slow start after sewing machine stops (After performing sewing machine stops, start the next sewing work slowly)	0	0/1	1=selection
13	When starting slowly, select sewing speed change	0	0/1	1=Use C14~C18 value 0=Use default value
14	The speed of the first stitch when starting slow	400spm	40~9960	40spm
15	The speed of the second stitch when starting slow	400spm	40~9960	40spm
16	The speed of the third stitch when starting slow	640spm	40~9960	40spm
17	The speed of the fourth stitch when starting slow	1000spm	40~9960	40spm
18	The speed of the fifth stitch when starting slow	1680spm	40~9960	40spm
19	Limited maximum motor speed	4000rpm	20~5000	20rpm
20	Synchronizer sensor rotation sensing time	40 × 0.1sec	5~1275	0.5sec
21	Overload sensing time	30 × 0.1sec	5~1275	0.5sec
22	NOT USED	100ms	4~1020	4ms
23	Power off sensing time	4ms	4~1020	4ms
24	NOT USED			
25	Bad signal of the Encoder A and B phase detecting number of time	4	1~255	1
26	Back signal of the Encoder R, S and T phase detecting number of time	4	1~255	1
27	Bad signal of the Encoder R, S and T phase detecting number of time	4	1~255	1
28	NOT USED			
29	<ul style="list-style-type: none"> • Automatic scaling to the speed curve selected by each set mode - Mode 0 : Use a curve based on the set values from C-1 to C-10 - Mode 1 : Scaling to the speed set at A-2 - Mode 2 : Scaling to the speed set using the Speed Up/Dn key 	1	1~2	1

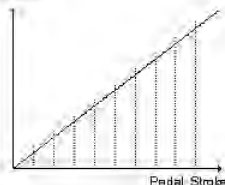

※ Items No. 1~5 : Equal division of pedal stroke in 64 steps, The speed curve of the pedal stroke changes according to how many steps are set up for the divided pedal stroke of each forward pedal step. (Used when adjusting pedal sensor)

※ No. 20 : If a synchronizer signal comes, but the next synchronizer signal does not come within the sensing time, an error message will appear .

※ No. 21 : If a speed instruction was sent to the motor but the motor does not reach the value of the speed instruction, an error message will appear.

[Caution]

If the specific items of the parameter are changed carelessly, they could break down or damage the machine, so the user must be well-trained before using it.

※ This item is operated by the factory only, so general users and A/S technicians should not use it.

No.	Function	Initial value	Step
30	OUTPUT00 (B/T Solenoid) : Low Active	0(Fixed)	※ Output port changing function - write the function number on the output PIN you want to change after referring to the table below
31	OUTPUT01 (P/F Solenoid) : Low Active	1(Fixed)	
32	OUTPUT02 (T/T Solenoid) : Low Active	2	
33	OUTPUT03 (W/P Solenoid) : Low Active	3	
34	OUTPUT04 (T/R Solenoid) : Low Active	4	
35	OUTPUT05 (Left Solenoid) : Low Active	5	
36	OUTPUT06 (Right Solenoid) : Low Active	6	
37	OUTPUT07 (AUX Solenoid) : Low Active	7	
38	OUTPUT10 (Left LED) : High Active	8	
39	OUTPUT11 (Right LED) : High Active	9	
40	OUTPUT12 (Needle upper stop notifying signal) : High Active	10	
41	OUTPUT13 (Needle lower stop notifying signal) : High Active	11	
42	OUTPUT14 (Signal notifying motor is running) : High Active	12	
43	OUTPUT15 (Signal notifying target has been reached) : High Active	13	

★ A : Output PIN function

Function No.	H/W type actual output name	Function No.	H/W type actual output name
0	B/T Solenoid (with duty)	100	inv. B/T Solenoid (with duty)
1	P/F Solenoid (with duty)	101	inv. P/F Solenoid (with duty)
2	T/T Solenoid (with duty)	102	inv. T/T Solenoid (with duty)
3	W/P Solenoid (with duty)	103	inv. W/P Solenoid (with duty)
4	T/R Solenoid (with duty)	104	inv. T/R Solenoid (with duty)
5	Left Solenoid (with duty)	105	inv. Left Solenoid (with duty)
6	Right Solenoid (with duty)	106	inv. Right Solenoid (with duty)
7	AUX Solenoid (with duty)	107	inv. AUX Solenoid (with duty)
8	Left LED (with duty)	108	inv. Left LED (with duty)
9	Right LED (with duty)	109	inv. Right LED (with duty)
10	"Needle Up-stop" notifying signal (with duty)	110	inv. Needle Up-Stopped (with duty)
11	"Needle Down-stop" notifying signal (with duty)	111	inv. Needle Down-Stopped (with duty)
12	"Sewing machine running" notifying signal (with duty)	112	inv. Motor Running (with duty)
13	"Target speed" notifying signal (with duty)	113	inv. Target Speed (with duty)
14	"Trimming" notifying signal (without duty)	114	inv. Trimming (without duty)
15	"End Back Tack" notifying signal (without duty)	115	inv. End Back Tack (without duty)
16	"Emergency stop" notifying signal (without duty) - A signal appears when the motor stops for any error.	116	inv. Emergency Stopped (without duty) - A signal appears when the motor stops for any error
17	Roller Lift Solenoid (without duty)	117	inv. Roller Lift Solenoid (without duty)
18	Hemming Device Output (without duty)	118	inv. Hemming Device Output (without duty)
19	"First step forward pedal" notifying signal (without duty)	119	inv. Pedal Start (without duty)
200	Low signal (without duty)	201	High signal (without duty)

※ If an output signal has been sent twice in the OUTPUT00~OUTPUT15 output pin, the same signal will appear in two different output pins.

Ex) if OUTPUT00 = 0 & OUTPUT03 = 0, then B/T signal is output from both OUTPUT00 & OUTPUT03 pin

※ When setting up other functions apart from the function numbers listed above, the pertinent output pin functions are disregarded.

※ Roller Lift Solenoid = Presser Foot-Lift solenoid + Back Tack solenoid + Roller Lift Switch

44~	NOT USED		
49	NOT USED		

[Caution]

If the specific items of the parameter are changed carelessly, they could break down or damage the machine, so the user must be well-trained before using it.



No.	Function	Initial value	Step
50	INPUT00 (Button A)	0	※ Output port changing function - Write the function number on the output PIN you want to change after referring to the table below
51	INPUT01 (Button B)	1	
52	INPUT02 (1/4 stitch Switch)	2	
53	INPUT03 (2/4 stitch Switch)	3	
54	INPUT04 (3/4 stitch Switch)	4	
55	INPUT05 (4/4 stitch Switch)	5	
56	INPUT06 (Left Sol. Switch)	6	
57	INPUT07 (Right Sol. Switch)	7	
58	INPUT10 (Presser Foot-Lift Switch)	8	
59	INPUT11 (Counter Switch)	9	
60	INPUT12 (P/U 1/2 stitch Switch Signal)	10	
61	INPUT13 (Safety Switch Signal)	11	
62	INPUT14 (Edge Sensor Signal)	12	
63	INPUT15 (Thread trimmer not allowed Signal)	13	
64	INPUT20 (Pedal Start Signal)	16	
65	INPUT21 (Pedal Presser Foot-Lift Signal)	17	
66	INPUT22 (Pedal Trim Signal)	18	

★ B : Input PIN function

No.	Actual Hardware Output Name	No.	Actual Hardware Output Name
0	Button A Switch	100	inv Button A Switch
1	Button B Switch	101	inv Button B Switch
2	1/4 stitch Switch	102	inv 1/4 stitch Switch
3	2/4 stitch Switch	103	inv 2/4 stitch Switch
4	3/4 stitch Switch	104	inv 3/4 stitch Switch
5	4/4 stitch Switch	105	inv 4/4 stitch Switch
6	Left Solenoid Switch	106	inv Left Solenoid Switch
7	Right Solenoid Switch	107	inv Right Solenoid Switch
8	Presser Foot-Lift Switch	108	inv Presser Foot-Lift Switch
9	Counter Switch	109	inv Counter Switch
10	Program Unit 1/2 stitch Switch	110	inv Program Unit 1/2 stitch Switch
11	Safety Switch	111	inv Safety Switch
12	Edge Sensor Signal	112	inv Edge Sensor Signal
13	Thread Trimmer Signal	113	inv Trimming Disabled Signal
14	Roller Lift Switch	114	inv Roller Lift Switch
15	N_AUTO Switch	115	inv N_AUTO Switch
16	Pedal Start Signal	116	inv Pedal Start Signal
17	Pedal Presser Foot-Lift Signal	117	inv Pedal Presser Foot-Lift Signal
18	Pedal Thread Trimming Signal	118	inv Pedal Thread Trimming Signal
19	External Signal	119	inv External Signal
20	Machine-Head-Open Switch	120	inv Machine-Head-Open Switch

※Caution : When any inputs PIN No. INPUT00 ~ INPUT22 are overlapped, it works as the "OR" circuit.

Ex) if INPUT00 = 0 & INPUT01 = 0, then it is recognized as "button A" = INPUT00 + INPUT01.

※ The hardware of input switches and sensors are done with "a point of contact/Active High" input as the standard.

※ When setting up other functions numbers apart from the ones listed above, the pertinent output pin functions are disregarded.

70	Output Signal Level Collective Reverse Function	0	0/1	1=Output signal Collective Reverse, selection
71	Input Signal Level Collective Reverse Function	0	0/1	1=Input signal Collective Reverse, selection
72~	NOT USED			
99	NOT USED			

[Caution]

If the specific items of the parameter are changed carelessly, they could break down or damage the machine, so the user must be well-trained before using it.

(4) Group D Parameter: All types of gain parameter related motor control

※ These are functions not used by general users and must be regulated by an A/S technician.

※ The set value which listed below may show difference depends on motor.

No.	Function	Initial Value	Range	Step
1	speed P-gain Kvp	20	0~30	1
2	speed D-gain Kvd	20	0~300	1
3	location P-gain Kpp	170	0~500	1
4	location D-gain Kpd	2000	0~3000	1
5	acceleration A accelA	40	1~50	1
6	acceleration B accelB	70	1~50	1
7	acceleration C accelC	40	1~50	1
8	acceleration D accelD	8	1~50	1
9	sewing machine inertia value Inertia	40	0~255	1
10	positioning speed Wpos	220 rpm	100~500	2 rpm
11	stopping speed Wstop	75 rpm	0~500	2 rpm
12	Stop delaying time StopDelay	80 ms	4~1020	4 ms
13	Positioning distance DIST1	80 degree	0~255	1 degree
14	upper speed instruction unit spd_unit	100 spm	1~100	1 spm
15	Positioning P-gain Kpp2	400	0~500	1
16	Positioning D-gain Kpd2	4000	0~5000	1
17	Positioning P-gain Kpp3	100	0~500	1
18	Positioning D-gain Kpd3	1800	0~5000	1
19	NOT USED			
20	Overload rate limit function setting	0	0/1	
21	Pre-set overload rate	100[%]	0~255[%]	If the rated voltage of a motor is 100[%], it can be set by 1[%].
22	Pre-set overload rate limit time	Depending on the pre-set overload rate, the limit time is automatically calculated.	Parameter exit and re-entry should be conducted.	
23~	NOT USED			
99	NOT USED			



- If the specific items of the parameter are changed carelessly, they could break down or damage the machine, so the user must be well-trained before using it.
- When you start tuning with the default values, the parameter values above will be adjusted to the load level and the set value will differ from the default value.

(5) Group F Parameter : TPM(Total Production Maintenance) related Parameters

No.	Function	Initial Value	Range	Step
1	TPM 1 Enable / Disable	0	0/1	0 : Disable 1 : Enable
2	TPM 2 Enable / Disable	0	0/1	0 : Disable 1 : Enable
3	TPM 3 Enable / Disable	0	0/1	0 : Disable 1 : Enable
4	TPM 4 Enable / Disable	0	0/1	0 : Disable 1 : Enable
5	TPM 5 Enable / Disable	0	0/1	0 : Disable 1 : Enable
6	TPM 6 Enable / Disable	0	0/1	0 : Disable 1 : Enable
7	TPM 7 Enable / Disable	0	0/1	0 : Disable 1 : Enable
8	TPM 8 Enable / Disable	0	0/1	0 : Disable 1 : Enable
9	TPM 9 Enable / Disable	0	0/1	0 : Disable 1 : Enable
10	Not Used			
11	TPM 1 time setting	750	1 ~9999	1[Hour]
12	TPM 2 time setting	1	1 ~9999	1[Hour]
13	TPM 3 time setting	1	1 ~9999	1[Hour]
14	TPM 4 time setting	1	1 ~9999	1[Hour]
15	TPM 5 time setting	1	1 ~9999	1[Hour]
16	TPM 6 time setting	1	1 ~9999	1[Hour]
17	TPM 7 time setting	1	1 ~9999	1[Hour]
18	TPM 8 time setting	1	1 ~9999	1[Hour]
19	TPM 9 time setting	1	1 ~9999	1[Hour]
20	Not Used			
21	Initialize the remain time when changing the TPM 1 set time.	1	0/1	0 : Disable 1 : Enable
22	Initialize the remain time when changing the TPM 2 set time.	1	0/1	0 : Disable 1 : Enable
23	Initialize the remain time when changing the TPM 3 set time.	1	0/1	0 : Disable 1 : Enable
24	Initialize the remain time when changing the TPM 4 set time.	1	0/1	0 : Disable 1 : Enable
25	Initialize the remain time when changing the TPM 5 set time.	1	0/1	0 : Disable 1 : Enable
26	Initialize the remain time when changing the TPM 6 set time.	1	0/1	0 : Disable 1 : Enable
27	Initialize the remain time when changing the TPM 7 set time.	1	0/1	0 : Disable 1 : Enable
28	Initialize the remain time when changing the TPM 8 set time.	1	0/1	0 : Disable 1 : Enable
29	Initialize the remain time when changing the TPM 9 set time.	1	0/1	0 : Disable 1 : Enable
30	Not Used			

 Caution	<p>Changing set values without thorough understanding of parameter details may lead to machine breakdown or physical damage. Users are recommended to have a full understanding of functions before use.</p>
---	--

No.	Function	Initial Value	Range	Step
31	Set the TPM 1 password entry function	0	0/1	0 : Disable 1 : Enable
32	Set the TPM 2 password entry function	0	0/1	0 : Disable 1 : Enable
33	Set the TPM 3 password entry function	0	0/1	0 : Disable 1 : Enable
34	Set the TPM 4 password entry function	0	0/1	0 : Disable 1 : Enable
35	Set the TPM 5 password entry function	0	0/1	0 : Disable 1 : Enable
36	Set the TPM 6 password entry function	0	0/1	0 : Disable 1 : Enable
37	Set the TPM 7 password entry function	0	0/1	0 : Disable 1 : Enable
38	Set the TPM 8 password entry function	0	0/1	0 : Disable 1 : Enable
39	Set the TPM 9 password entry function	0	0/1	0 : Disable 1 : Enable
40	Not Used			
41	Enable the TPM function	1	0/1	0 : Disable 1 : Enable
42	Set the TPM password entry function	1	0/1	0 : Disable 1 : Enable
43	Machine rated speed	3600[spm]	40~5000[spm]	40[spm]
44	Environmental variable applied in the event of the set time reduction	20	0 ~ 20	1
45	Speed adjustment unit when adjusting time in line with current speed	400[spm]	400~2000[spm]	40[spm]
46	TPM test mode (900[Stitch]/1[Hour])	0	0/1	0 : Disable 1 : Enable
47	Not Used			
48	Not Used			
49	Not Used			
50	User password	0000	0000 ~ 9999	1



Caution

Changing set values without thorough understanding of parameter details may lead to machine breakdown or physical damage. Users are recommended to have a full understanding of functions before use.

3) Method of Use and Explanations for Specific Items of the Parameter

(1) Method of Use and Explanations for Specific Items of the Group A Parameter

(General functions of sewing machine)

A. Minimum/maximum sewing speed limit set up method and thread trimming speed set up method

Item No.	Name of function	Method of use and explanation
A-1	Minimum sewing speed limit set up	This item allows user to set up the minimum sewing speed limit or the minimum sewing speed given when the pedal is pressed.(20~510rpm, Initial value : 200rpm)
A-2	Maximum sewing speed limit set up	This item allows user to set up the maximum sewing speed limit or the maximum sewing speed given when the pedal is pressed.(40~9960rpm, Initial value : 4000rpm)
A-3	Thread trimming speed set up	This item allows the user to set up the thread trimming speed when the thread trimming function is operating after sewing

B. Set up method of 1/2 stitch speed by program unit(P/U) and needle plate lift/drop by button A

Item No.	Name of function	Method of use and explanation
A-4	Set up method of 1/2 stitch speed by program unit (P/U)	This item allows user to set up the 1/2 stitch speed by program unit (P/U) and hence sets up the 1/2 stitch operating speed. However, if set up to a rapid speed, many stitches may be sewn after pressing the button.
A-5	Set up the speed of lift/drop of needle plate with button A	This item allows user to set up the speed of lift/drop of the needle plate with button A. However, if set to a rapid speed, many stitches may be sewn after pressing the button.

C. Start B/T sewing speed and end B/T sewing speed set up method

Item No.	Name of function	Method of use and explanation
A-7	Start B/T speed set up	This item allows user to set up the start B/T speed. If the speed is changed, the stitch correction value also has to be set again.
A-8	End B/T speed set up	This item allows user to set up the end B/T speed. If the speed is changed, the stitch correction value also has to be set again.

D. Selection method of thread trimming location with pedal

Item No.	Name of function	Method of use and explanation
A-19	Start B/T speed set up	You can change the thread trimming operation through pedal position by making the following changes to the set up values. <ul style="list-style-type: none"> • 0 : When the pedal position is backward 2 gear, operate thread trimming(Starting set up value). • 1 : When pedal position is backward 1 gear, operate thread trimming • 2 : When pedal position is neutral, operate thread trimming.

E. Edge Sensor method of use Item No.

Item No.	Name of function	Method of use and explanation
A-40	Selection of edge sensor type	The set up method changes according to the set up parts of edge sensor <ul style="list-style-type: none"> • 0 : When edge is sensed and using high output sensor. • 1 : When edge is sensed and using low output sensor.
A-41	Stitches performed after edge sensor sensing	A function that programs the machine to stop after sewing a programmed amount of stitches when edge is sensed.
A-42	Sewing speed of stitches performed after edge sensor sensing	A function that programs the sewing speed after sewing a programmed amount of stitches when edge is sensed.
A-46	Selection of edge sensing sewing mode (select N-stitch mode)	A function that programs the edge sensor to operate normally, even when other sensor signals are inputted in the edge sensor port.

[Caution]

If the specific items of the parameter are changed carelessly, they could break down or damage the machine, so the user must be well-trained before using it.

F. Pre-stitch function method of use and explanation

Item No.	Name of function	Method of use and explanation
A-47	Selection of pre-stitch function	The pre-stitch function is a function that programs the machine to sew a certain amount of stitches before commencing the actual sewing work.(0 : disable, 1 : enable)
A-48	Set pre-stitching stitch number	This item sets the number of stitches when using the pre-stitch function (0~255 stitches, Initial value : 3 stitches)
A-49	Set pre-stitching speed	This item sets the sewing speed when using the pre-stitch function. (20~2000rpm, Initial value : 2000rpm)

G. Method to select beginning/ending reverse sewing conditions

Item No.	Name of function	Method of use and explanation
A-50	Selection of start B/T conditions (Initial value : 1)	The start B/T function can be one of the following three operations according to their set up value <ul style="list-style-type: none"> • 0 : If user releases pedal during B/T operation, sewing stops. • 1 : If user releases pedal during B/T operation, sewing stops after finishing work. • 2 : The exact amount of stitches is operated, notwithstanding the number of stitch corrections. However, if this function is used, B/T will no operate naturally.
A-51	Selection of end B/T conditions (Initial value : 0)	This item selects whether or not to use the end B/T's exact number of stitches function operation <ul style="list-style-type: none"> • 0 : exact number of stitches function disabled • 1 : exact number of stitches function enabled (If this function is used, reverse sewing will no operate naturally)
A-52	The speed of the first stitch during B/T exact performance	This item selects the speed of the initial reverse stitch when user has selected the exact number of stitches function in the B/T operation(20~1000rpm, Initial value : 200rpm)

H. Method to select buttons A/B functions

Item No.	Name of function	Method of use and explanation
A-54	Selection of button A function (Initial value : 2)	The function of button A can be one of the following four operations according to their set up value. <ul style="list-style-type: none"> • 0 : If user presses A button while sewing, B/T sewing is operated while user keeps on pressing it. • 1 : If user presses the A button while sewing, B/T sewing is operated. If user stops sewing and presses A button once the needle plate is lifted. If user presses it once more, the needle plate is dropped • 2 : If user presses the A button while sewing, B/T sewing is operated while user keeps on pressing it. If user stops sewing and presses A button once, the needle plate is lifted. If user presses it twice consecutively, the needle plate is dropped. • 3 : If user presses A button while sewing, B/T sewing is operated while user keeps on pressing it. When user stops sewing and presses the A button, 1/2 stitch speed is operated.
A-55	Selection of button B function (Initial value : 0)	The function of button A can be one of the following four operations according to their set up value. <ul style="list-style-type: none"> • 0 : This item has the function of inserting/deleting the B/T sewing when user presses the B button. If the user presses the B button where there is no B/T sewing section, B/T sewing is inserted and when it is pressed where there is a B/T sewing section, B/T sewing is deleted. • 1 : If user presses the B button once, the needle plate is lifted and if user presses it once more, it is dropped • 2 : When user stops sewing and presses the B button, 1/2 stitch speed is operated while user presses it. • 3 : When sewing, B/T sewing is operated while user presses B button.

I. Method of use of motor rotating direction selection function

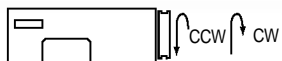
Item No.	Name of function	Method of use and explanation
A-65	Selecting the motor's rotating direction	This item sets up the set up value according to the motor's rotating direction <ul style="list-style-type: none"> • 0 : clockwise rotation • 1 : counterclockwise rotation(Initial value) 

[Caution]

If the specific items of the parameter are changed carelessly, they could break down or damage the machine, so the user must be well-trained before using it.

(2) Group B Parameter Specific Method of Use and Explanation (All types of output, Full-on Time/PWM Duty, checking the input/output movements, sewing machine models and thread trimming sequence programming)

※ These are functions not used by general users and should be regulated by an A/S technician.

A. All types of output Full-on Time/PWM Duty time set up method (all types of solenoids, LED and signals)

Item No. B-1 ~ B-28

<Type of wave that has a certain amount of Full-on Time and 50% duty>

This figure explains the Full-on Time and PWM Duty. This figure shows the wave type graph where the machine maintains the power 'ON' for a certain amount of time and when that 'Full-on Time' passes, changes itself to a PWM signal with a certain duty. In other words, the certain amount of time that each device starts operating until they become completely, the output wave type maintains itself "On", and when it maintains itself operating the output becomes the duty PWM wave type to maintain operation.

B. B/T stitch correction set up method

Item No.	Name of function	Method of use and explanation	
B-30	Start B/T A side stitch correction value	This item has the function of correcting the B/T sewing stitch that has not been shaped well, and you can change the value of sides A, B, C, D. • The programmed value in the beginning A : 3, B : 3, C : 4, D : 4 • Program range : 0 ~ 9	
B-31	Start B/T B side stitch correction value		
B-32	End B/T C side stitch correction value		
B-33	End B/T D side stitch correction value		
<ul style="list-style-type: none"> • If the stitch correction values is changed using the program unit, the item value will automatically change. Reversely, if you change the programmed value of the items above, the stitch correction values will also automatically change. • Detailed correction principles and methods of use are the same as the program unit's stitch correction method. Please refer to the program unit method of use of start/end B/T stitch correction method. 			

C. Counter function method of use

Item No.	Name of function	Method of use and explanation
B-35	Counter condition set up	For detailed method of use and explanation of counter function, refer to the program unit's counter set up button method of use.
B-36	When using automatic counter after trimming, select increasing/decreasing counter	
B-37	After counter operation is over, set up the next operation	
B-38	After counter operation is over, select the automatic erasing operation	

[Caution]

If the specific items of the parameter are changed carelessly, they could break down or damage the machine, so the user must be well-trained before using it.

(3) Group C Parameter Specifics Method of Use and Explanation

(Pedal acceleration/deceleration curve, slow starting speed, input/output port change related parameter)

※ These are functions not used by general users and should be regulated by an A/S technician.

A. Pedal stroke step by step section and speed set up method

Item No.	Name of function	Beginning value	Method of use and explanation
C-1	pedal forward first step section	17	After dividing the pedal stroke to 64 steps, the pedal stroke's acceleration/deceleration curve changes according to which stroke step is programmed from pedal forward steps 1 through 5.
C-2	pedal forward second step section	22	
C-3	pedal forward third step section	38	
C-4	pedal forward fourth step section	47	
C-5	pedal forward fifth step section	59	
C-6	sewing speed during pedal forward first step	440rpm	The pedal stroke's acceleration/deceleration curve changes according to how the pedal forward step by step sewing speed set up is done.
C-7	sewing speed during pedal forward second step	920rpm	
C-8	sewing speed during pedal forward third step	4000rpm	
C-9	sewing speed during pedal forward fourth step	5480rpm	
C-10	sewing speed during pedal forward fifth step	9960rpm	

B. Slow-start sewing method of use : this function allows to start the sewing slowly and the user can set up the following specific items.

Item No.	Name of function	Method of use and explanation
C-11	Slow Start after thread trimming	These items help you choose at which point you can apply slow start. If you want to apply it after thread trimming set item No. C-11 value to 1. If you want to apply it after when you start sewing after stopping set item No. C-12 to 1. If both these items are set to 0, the slow starting function will not operate.
C-12	Slow Start after sewing machine stops	
C-13	When Slow Starting, change Slow- starting speed	When using the slow start function, this item gives you the option of maintaining the same starting speed or setting up a new speed. If you want to set up a new speed, use items No. C-14~C-18 and set up a new speed.
C-14	When Slow Starting, the operation speed of beginning stitch	When the item No. C-13 set up value is "1", the slow start beginning values (the specific items that change the set up value) are • 1 : 400rpm • 2 : 400rpm • 3 : 640rpm • 4 : 1000rpm • 5 : 1680rpm
C-15	When Slow Starting, the operation speed of second stitch	
C-16	When Slow Starting, the operation speed of third stitch	
C-17	When Slow Starting, the operation speed of fourth stitch	
C-18	When Slow Starting, the operation speed of fifth stitch	

C. Motor maximum speed limit set up method

Item No.	Name of function	Method of use and explanation
C-19	Set up motor maximum speed limit	This function allows you to limit the maximum motor speed, and the starting value is set to 3000 rpm.

[Caution]

If the specific items of the parameter are changed carelessly, they could break down or damage the machine, so the user must be well-trained before using it.

4) Thread Trimming Sequence Function Method of Use (Items no. 54, 55, 56 of Group B)





※ Thread trimming sequence function characteristics

- The thread trimming sequence is a user programming function of PLC control type used for thread trimming or when a special simple repetitive function is required .
- The user composes the thread trimming sequence he wants, and can program the machine or motor's operation during thread trimming.
- When necessary, the user can change it to exclusive mode and can program all types of special operations.
- The program size is 64 bytes, so compose the program within this size limit.
- The program code is composed of the command field and the data field.
- The thread trimming related parameters are items No. 54, 55, 56 from Group B.

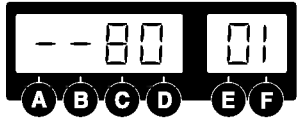
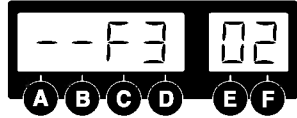

Item No.	Function
B-54	This item that provides the function of thread trimming sequence selection which allows the user to select and use the sequence from item No. B-55
B-55	This item provides the function of allowing the user to compose the thread trimming sequence himself.
B-56	This item provides the function of allowing the user to select other company sewing machine models, and makes automatic changes in the thread trimming sequence that fit the selected sewing machine.

(1) Thread Trimming Sequence Function Related Parameter Method of Use and Explanations (Full-Option)

A. Thread Trimming Sequence Data Input Function (Item No. B-55)

<p>① This function allows the user to compose the thread trimming sequence himself. In order to do this, the user must first enter parameter Group B.</p>	
<p>② If the screen changes, go to the specific items and choose item No. 55 from Group B. Then the user will see the letter "Seq" blink. (Use buttons E , F)</p>	
<p>③ If you press the ENTER button where it says "Seq 55", you can now choose the thread trimming sequence. In the figure, you can see the command "--80" which indicates the sequence start. The command "01" is a number within the sequence (01~64) of the "--80" command.</p>	
<p>④ If you use buttons E , F to increase the numbers, you can see the sequence that was set up in the start. Their contents are explained below</p> <ul style="list-style-type: none"> • 01 : "--08" ⇒ Sequence starting code • 02 : "--F3" ⇒ General sequence • 03 : "--00" ⇒ Sequence ending code 	
<p>⑤ Now the user can change the sequence function according to his objectives but the remember that the program size cannot exceed 64 bytes. Also you can set up several short sequences and then use the sequences you want by using item No. B-54. When you setting this up, each sequence must always have a starting and ending code. ※Refer to sequence code list</p>	
<p>[Caution]</p> <ul style="list-style-type: none"> • If you don't press the ENTER button after changing the parameter item set up value, the set up value will not be saved, so use caution when using it. • If the specific items of the parameter are changed carelessly, they could cause breakdown or damage the machine. Therefore, the user must be well-trained before using it. 	

B. Thread Trimming Sequence Selection Function Method of Use (Item No. B-54)

<p>① This function is used when the user wants to use other sequences apart from the sequences that are basically provided. If you want to use this function, first enter Item No.54 in parameter Group B. Then you will see the screen shown in the figure.</p>	
<p>② The starting value is set to "0". If you change this number to a value in the sequence of Item No. B-55, you can now use the extra programmed sequence. (Use the C , D buttons) (Ex : if you want to use the fourth sequence and change the sequence set up)</p>	
<p>③ The user can use Item No. B-55 to save and use several frequently used sequences whenever he needs them.</p>	
<p>[Caution]</p> <ul style="list-style-type: none"> • If you don't press the ENTER button after changing the parameter item set up value, the set up value will not be saved, so use caution when using it. • If the specific items of the parameter are changed carelessly, they could cause breakdown or damage the machine. Therefore, the user must be well-trained before using it. 	

C. Thread Trimming Sequence Automatic Change According to Sewing Machine Model Selection (Item No. B-56)

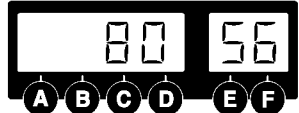
<p>① This function allows automatic change of thread trimming sequence when user attaches the controller to a sewing machine other than the one being currently used. If you want to use this function, first enter Item No.56 in parameter Group B. You will see then the screen shown in the figure.</p>	
<p>② If you press the ENTER button after changing the set up value to fit the new sewing machine model number, the matching thread trimming sequence is duplicated. ※Refer to the sewing machine list (Ex : when using the SunStar KM-790BL-7 sewing machine)</p>	
<p>③ The duplicated thread trimming sequence can be check in the Item No. B-55 and if you want to change the contents you can do so using Item No. B-55</p>	
<p>[Caution]</p> <ul style="list-style-type: none"> • If you don't press the ENTER button after changing the parameter item set up value, the set up value will not be saved, so use caution when using it. • If the specific items of the parameter are changed carelessly, they could cause breakdown or damage the machine. Therefore, the user must be well-trained before using it. 	





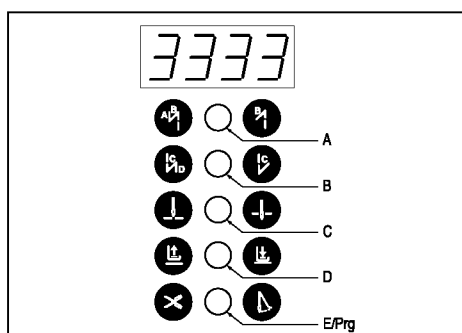

(2) Thread Trimming Sequence Function Related Parameter Method of Use and Explanations (Economic)

A. Changing the Trimming Sequence with the Simplified Operation Panel

When changing the thread trimming sequence by using the simplified operation panel, the method is a bit different from when changing other parameters. Check the following manual and make the changes in a correct manner.

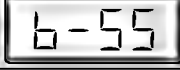

<S- V| Simplified Operation Panel>

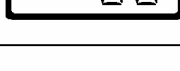
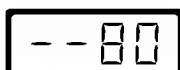
	How to Operate	Display	Remarks
1	Press E/Prg button and A button simultaneously. Then the screen for changing parameters appears.		• Program Enable
2	Press B button, and it moves to the parameter B group.		• Parameter B-01
3	Use A button and B button to move to the No. 55 trimming sequence of the B group.		• Parameter B-55
4	Press C button when "b-55" is displayed. Then "SEQ" blinks on the screen.		• Sequence
5	Press C button once again, and the screen displays the starting location number of trimming sequence.		• -80" : Trimming sequence start command
6	Press A button and B button to change the location number of the current trimming sequence. ex) When A is pressed, "--80" is changed to "--81".		• The starting location number of trimming sequence has changed from "--80" to "--81".
7	When C button or D button is pressed, the trimming sequence location number increases or decreases. The screen displays the values stored in the concerned sequence location. ex) When C is pressed, the screen displays "--83", the value which is in the second trimming sequence location.		• In case where Model = 88, the "--83" command is stored in the second trimming location.
8	When the trimming sequence change is complete following the above procedure, press E/Prg button to store the sequence.		• Trimming sequence is stored.
9	<p>[Notice]</p> <ul style="list-style-type: none"> • Please make sure that in case of a simplified operation panel, the location value of the current trimming sequence is not shown. • Please make sure that in case of a simplified operation panel, the functions of the buttons A, B, C, D, E are a bit different from those when they are used in other context. • In order to exit the trimming sequence change mode, press "E". Then all the changed values will be stored. • If you want to make several changes, press "E" one time after all changes are made to save the changed values. 		

(3) Basic Structure of Thread Trimming Sequence Program Code

A. The thread trimming sequence program code is basically composed of the command field and data field which comes according to the command field. The size of the program cannot exceed 64 bytes.

Explanation of function		Command field	Data field		
			1st	2nd	3rd
PosStopUp	Needle plate up-stop after sewing given stitch numbers at given speed.	CEH	0~5000[rpm](20rpm)	0~255[stitch]	

B. The table above is an example of the program code structure. If you want to use the function "Needle plate up-stop after sewing given stitches at given speed" you must first select the command code "CEH" and set up the data value according to the command code. In other words, the given sewing speed is the first data and the given stitch numbers is the second data and both of these form the data field. Depending on the command code, there can exist a data field or exist three data in the data field.

(4) Thread Trimming Sequence Program Code List

Category	Explanation	Cmd Field	Data Field		
			1st	2nd	3rd
Output Port Control (Total 40)	B/T Solenoid	On	81H		
	P/F Solenoid	On	82H		
	T/T Solenoid	On	83H		
	W/P Solenoid	On	84H		
	T/R Solenoid	On	85H		
	Left Solenoid	On	86H		
	Right Solenoid	On	87H		
	AUX Solenoid	On	88H		
	Left LED	On	89H		
	Right LED	On	8AH		
	Needle Up Signal	On	8BH		
	Needle Down Signal	On	8CH		
	Motor Runing Signal	On	8DH		
	Reaching Target Speed Signal	On	8EH		
	Motor Trimming Signal	On	8FH		
	Motor End Tacking Signal	On	90H		
	Emergency Stop Signal	On	91H		
	Roller Lift Solenoid	On	92H		
	Hemming Device Output	On	93H		
	Pedal Forward Step1 Signal	On	94H		
	B/T Solenoid	Off	98H		
	P/F Solenoid	Off	99H		
	T/T Solenoid	Off	9AH		
	W/P Solenoid	Off	9BH		
	T/R Solenoid	Off	9CH		
	Left Solenoid	Off	9DH		
	Right Solenoid	Off	9EH		
	AUX Solenoid	Off	9FH		
	Left LED	Off	A0H		
	Right LED	Off	A1H		
	Needle Up Signal	Off	A2H		
	Needle Down Signal	Off	A3H		
	Motor Runing Signal	Off	A4H		
	Reaching Target Speed Signal	Off	A5H		
	Motor Trimming Signal	Off	A6H		
	Motor End Tacking Signal	Off	A7H		
	Emergency Stop Signal	Off	A8H		
	Roller Lift Solenoid	Off	A9H		
	Hemming Device Outout	Off	AAH		
	Pedal Forward Step1 Signal	Off	ABH		
Time Delay	Delay by 1[ms] unit		B0H	0~255[ms] (1ms)	
	Delay by 2[ms] unit		B1H	0~510[ms] (2ms)	
	Delay by 4[ms] unit		B2H	0~1020[ms] (4ms)	
	Delay by 0.5[s] unit		B3H	0~127.5[s] (0.5s)	



Category	Explanation		Cmd Field	Data Field		
				1st	2nd	3rd
Motor Control	On Hold	Motor—Holding Start	C0H			
	Off Hold	Motor—Holding Stop	C1H			
	Set Dir CW	Set CW direction)	C2H			
	Set Dir CCW	Set CCW direction)	C3H			
	Set Speed	Make Motor Run with given Speed	C4H	0~500 [spm] (20spm)		
	Set SpdByPed	Make Motor Run with Speed given by pedal	C5H			
	Up Stop	Make Stop Needle Up (stop)	C6H			
	Dn Stop	Make Stop Needle Down (stop)	C7H			
	Up Stop InSpd	Make Up Stop with given Speed (stop)	C8H	0~500 [spm] (2spm)		
	Dn Stop InSpd	Make Dn Stop with given Speed (stop)	C9H	0~500 [spm] (2spm)		
	Dacc Up Edge	Decel. Speed at Up Edge (not stop)	CAH	0~500 [spm] (2spm)		
	Dacc Dn Edge	Decel. Speed at Dn Edge (not stop)	CBH	0~500 [spm] (2spm)		
	Move Up Edge	Move Up Edge with given Speed (stop)	CCH	0~500 [spm] (2spm)		
	Move Dn Edge	Move Dn Edge with given Speed (stop)	CDH	0~500 [spm] (2spm)		
	Pos Stop Up	Up Stop after sewing given stitch with given Speed	CEH	0~500 [spm] (20spm)	0~255 [stitch]	
	Pos Stop Dn	Dn Stop after sewing given stitch with given Speed	CFH	0~500 [spm] (20spm)	0~255 [stitch]	
	Pos Dacc Up	Dacc Dn Edge after sewing given stitch with given Speed	D0H	0~500 [spm] (20spm)	0~500 [spm] (2spm)	0~255
	Pos Dacc Dn	Dacc Up Edge after sewing given stitch with given Speed	D1H	0~500 [spm] (20spm)	0~500 [spm] (2spm)	0~255
	L Move Stop	Move given distance with given Speed	D2H	0~500 [spm] (2spm)	0~357 [deg]	
	SpdInPos	Make given Speed given Position	D3H	0~500 [spm] (20spm)	0~357 [deg]	
Rando Stop	Stop	D4H				
Position /Speed Check	Wait Pos1	When position already passed, return	E0H	0~357 [deg]		
	Wait Pos2	When position already passed, wait next position and	E1H	0~357 [deg]		
	Wait Up Edge	Wait until Up Edge detected.	E2H			
	Wait Dn Edge	Wait until Dn Edge detected	E3H			
	Chk Pos	Check the position passed & branch to the address	E4H	0~357 [deg]	0~64 (address)	
	Chk Up Edge	Check Up Edge detected & branch to the address	E5H	0~64 (address)		
	Chk Dn Edge	Check Dn Edge detected & branch to the address	E6H	0~64 (address)		
	Clr Up Edge	Clear Up Edge FG (mark UpEdge detected)	E7H			
	Clr Dn Edge	Clear Dn Edge FG (mark DnEdge detected)	E8H			
	Wait Speed	Wait until speed is target speed	E9H	0~500 [spm] (20spm)		
	Chk Speed	Check speed is target speed & branch to the address	EAH	0~357 [deg]	0~64 (address)	

Category	Explanation		Cmd Field	Data Field		
				1st	2nd	3rd
Input Port Check WaitPort	Wait until the port signal detected	Button A	F0H	0 (Input Port No)		
		Button B				
		Switch 1/4 stich		2		
		Switch 2/4 stich		3		
		Switch 3/4 stich		4		
		Switch 4/4 stich		5		
		Left Solenoid Switch		6		
		Right Solenoid Switch		7		
		Pressor Foot Switch		8		
		Counter Switch		9		
		Button 1/2 switch P/U Box		0		
		Safety Switch		1		
		Edge Sensor		2		
		Running Disable Switch		3		
		Roller Switch		4		
		1-AUTO Switch		5		
		Pedal Start Input		6		
		Pedal Pressor-Foot Input		7		
		Pedal Thread Running Input		8		
		External Input		9		
BrChkPort (Check the port and branch the given address)		Button A	F1H	0 (Port	0~64 (address)	
		Button B			0~64	
		Switch 1/4 stich		2	0~64	
		Switch 2/4 stich		3	0~64	
		Switch 3/4 stich		4	0~64	
		Switch 4/4 stich		5	0~64	
		Left Solenoid Switch		6	0~64	
		Right Solenoid Switch		7	0~64	
		Switch		8	0~64	
		Counter Switch		9	0~64	
		Button 1/2 switch P/U Box		0	0~64	
		Safety Switch		1	0~64	
		Edge Sensor		2	0~64	
		Running Disable Switch		3	0~64	
		Roller Switch		4	0~64	
		1-AUTO Switch		5	0~64	
		Pedal Start Input		6	0~64	
		Pedal Pressor-Foot Input		7	0~64	
		Pedal Thread Running Input		8	0~64	
		External Input		9	0~64	
Sequence Control	Branch	Branch given address	F2H	0~64 (Address)		
	GenSeq	General Tripping Sequence	F3H			
	StartSeq	Start the sequence	80H			
	EndSeq	End of the sequence	00H			

[Caution]

- Every the conditional Branch is made to the appropriate number when it is on "No(False)"
- When making the sequence program, please check and use its function because the wrong sequence program can cause the mechanical trouble and the physical damage.

(5) Examples of the Function of Thread Trimming Sequence

● Yamato Three-needle Trimming

① Timing of Thread Trimming Sequence

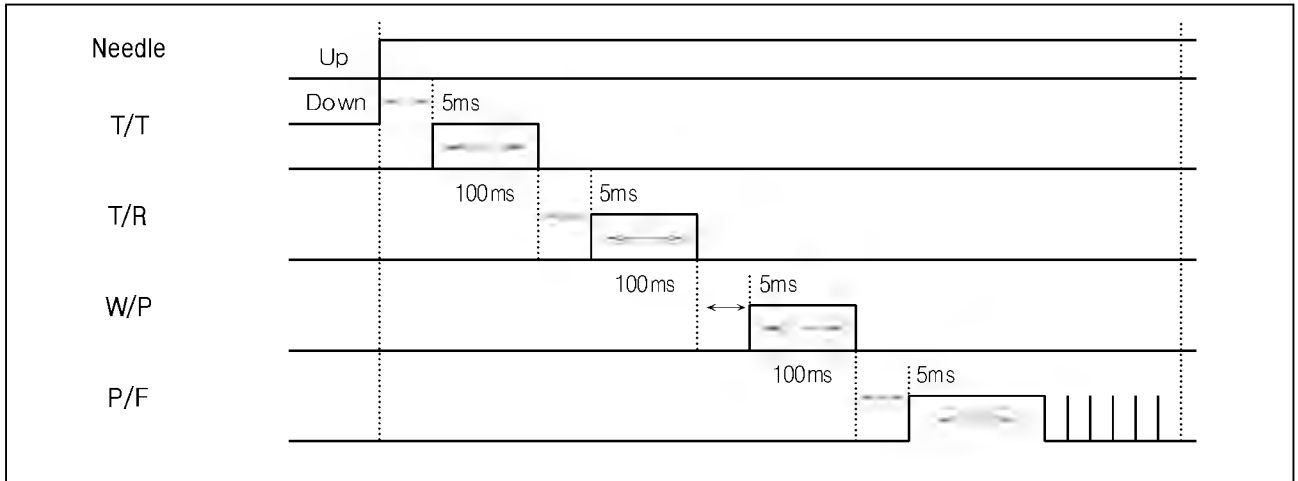

② Flow Chart of Tread Trimming Sequence & Program Code

Flow chart	Code number	Comm. field	Data field			Explanation
			1st	2nd	3rd	
START of Sequence	01	--80				Start of Sequence
Needle Up Stop with 200spm	02	--C8				Stop after moving to needle of upstop at 200spm
wait for 5ms	03		200			
T/T sol. on	04	--B0				Wait for 5[ms]
wait for 100ms	05		5			
sol. off	06	--83				Thread Trimming solenoid , On
wait for 5ms	07	--B0				Wait for 100[ms]
/R sol. on	08		100			
wait 100ms	09	--9A				T/T sol.(off)
T/R sol. off	10	--B0				Wait for 5[ms]
wait for 5ms	11		5			
W/P sol. on	12	--85				T/R sol.(on)
wait 100ms	13	--B0				Wait for 100[ms]
T/R sol. off	14		100			
wait for 5ms	15	--9C				T/R sol.(off)
W/P sol. on	16	--B0				Wait for 5[ms]
wait 100ms	17		5			
W/P sol. off	18	--84				W/P sol.on(on)
wait for 5ms	19	--B0				Wait for 100[ms]
End Sequence	20		100			
	21	9B				Wiper solenoid off
	22	--B0				Wait for 5[ms]
	23		5			
	24	00				End of Sequence

※ Operates Presser Foot Solenoid by "Letting Up function of Automatic Presser Foot after Trimming" being set to A18=1

※ As every command field is displayed close to "--", it is distinguishable from Data Field

※ All Data Fields are displayed easily enough to distinguish them from others, differently from S-II and there's no necessity of transforming the number and conversing the unit

(6) List of Codes by Machine Model – (able to choose from No. 56 of GROUP “B”)

NO.	TYPE of Sewing	T/T Solenoid type	Sewing Machine	ORDER NO.	GROUP									PROGRAM UNIT SETTING						SYNC.	RULLEY SIZE
					A					B		C	S/B/T	E.B/T	NEEDLE	P/F	T/T	W/P			
					A2	A3	A7	A8	A24	A65	B16	B56							C61		
1	SINGLE	CAM	KM-2300MG , KM-2310MG	S4AC50- - -	4000	300	1700	1700		1	20	0	20	ON	ON	DOWN	DOWN	ON	ON		
2			KM-2300SG, KM-2300MB, KM-2310MB	S4AC50	4000	300	1700	1700		1	20	76	20	ON	ON	DOWN	DOWN	ON	ON		
3			KM-2300MH, KM-2300MA, KM-2300SA	S4AC50- - -	4000	300	1700	1700		1	20	77	20	ON	ON	DOWN	DOWN	ON	ON		
4			KM-2300FG	S4AC50	3520	300	1700	1700		1	20	78	20	ON	ON	DOWN	DOWN	ON	ON		
5			KM-2300FA	S4AC50	3520	300	1700	1700		1	20	79	20	ON	ON	DOWN	DOWN	ON	ON		
6	Double	CAM	KM-1750MG	S4AC50- - -007	3000	180	800	800		1	50	80	120	ON	ON	DOWN	DOWN	ON	ON		
7			KM-1750MBL, KM-1751BL	S4AC50- - -008	3000	180	800	800		1	50	81	120	ON	ON	DOWN	DOWN	ON	ON		
8			KM-1750SF	S4AC50- - -009	2600	180	800	800		1	50	82	120	ON	ON	DOWN	DOWN	ON	ON		
9			KM-1790MG	S4AC50- - -010	2800	180	800	800		1	50	83	120	ON	ON	DOWN	DOWN	ON	ON		
10			KM-1790MBL	S4AC50- - -011	2600	180	800	800		1	50	84	120	ON	ON	DOWN	DOWN	ON	ON		
11			KM-1791BL	S4AC50- - -012	2800	180	800	800		1	50	85	120	ON	ON	DOWN	DOWN	ON	ON		
12	CHAN	AIR	SC-7300	S4AC50-□DE-006	4000	200	1600	1600		1	50	88	11	OFF	OFF	DOWN	DOWN	ON	ON		
13	CHAN	AIR	SC-7300 (for tinsel trimming)	S4AC50-□DE-007	4000	200	1600	1600		1	50	123	11	OFF	OFF	DOWN	DOWN	ON	ON		
14	CHAN	AIR	SF-7500	S4AC50-□DE-008	5000	200	1600	1600		1	50	124	11	OFF	OFF	DOWN	DOWN	ON	ON		
15	CHAN	AIR	SC-7310	S4AC50-□DE-009	4000	200	1600	1600		1	50	125	11	OFF	OFF	DOWN	DOWN	ON	ON		

(7) F-4 750[W] GSP GODE

M/C Model	GSP CODE	Model	Max. Sewing Speed	Default Speed	Trimming Speed	Start Backtack Speed	End Backtack Speed	Trimming Condition	Backward Rotation After Trimming	Backward Rotation After Trimming	Rotary Direction of Motor
		B 56	C 24	A 2	A 3	A 7	A 8	A 24	A 60	A 61	A 65
KM-1070BLX	S4AC75-□A-101	101	3480	3000	150	600	600	0	1	50	0
KM-1070BLX-7		101	3480	3000	150	600	600	0	1	50	0
KM-1070BLXH	S4AC75-□A-102	102	2800	2800	150	600	600	0	1	50	0
KM-1070BLXH-7	S4AC75-□A-103	103	2800	2800	150	600	600	0	1	50	0
KM-1072BLX	S4AC75-□A-104	104	3480	3000	150	600	600	0	1	50	0
KM-1072BLX-7		104	3480	3000	150	600	600	0	1	50	0
KM-1072BLX-7(D)	S4AC75-□A-105	105	3480	3000	150	600	600	0	1	50	0
KM-1072BLXH	S4AC75-□A-106	106	2000	2000	150	600	600	0	1	50	0
KM-1080BL	S4AC75-□A-107	107	2520	2120	150	600	600	0	1	50	0
KM-1080BL-7		107	2520	2120	150	600	600	0	1	50	0
KM-1080BLH	S4AC75-□A-108	108	2000	2000	150	600	600	0	1	50	0
KM-1080BLH-7	S4AC75-□A-109	109	2520	2120	150	600	600	0	1	50	0
KM-1082BL	S4AC75-□A-110	110	2520	2120	150	600	600	0	1	50	0
KM-1082BL-7		110	2520	2120	150	600	600	0	1	50	0
KM-1082BL-7(D)	S4AC75-□A-111	111	2520	2120	150	600	600	0	1	50	0
KM-1082BLH	S4AC75-□A-112	112	2000	2000	150	600	600	0	1	50	0



11

BREAKDOWN AND TROUBLESHOOTING

※ If the machine breaks down while using the servo motor due to an unforeseen change in the machine, the error indicators mentioned below will appear in the display of the program unit or simple program unit according to the self-checking function of the machine. The machine will then stop along with the sound of a warning buzzer. When an error indicator appears, follow the solution steps described below and resume work. If the problem is not solved after taking these measures, contact a company branch office.

Order	Error indicator	Cause of breakdown	Troubleshooting
1	SF22 Er	Safety switch error	• Check safety switch cable and connector
2	PU26 Er	Trouble with program unit connection	• Check program unit cable and connector
3	PU27 Er	Trouble with simple program unit connection	• Check the simple program unit cable and connector
4	60 Er	This error sign is seen when the user connects the location sensor while the power is still on	• Turn the power off and on again before using it.
5	61 Er	This error sign is seen when the user the user removes the location sensor while the power is still on	• Turn the power off and on again before using it.
6	126 Er	This error sign is seen when the motor's rotor magnet and stator coil's electric current flow does not match	• Check the condition of the motor's
7	127 Er	This error sign appears when the direction of encoders R S T and the direction of A B do not match.	• Check the encoder cable and the connector
8	128 Er	When there is no signal from encoders R S T	• Check the encoder cable and the connector
9	129 Er	When the motor is overloaded	• Turn the machine manually and check the machine load
10	130 Er	When there is no signal from the location sensor	• Check the location sensor cable and connector
11	131 Er	When there is an electric current overflow in the motor and problems with the connector	• Check the motor cable and the connector
12	132 Er	When the speed cannot be estimated	• Turn off the power and turn it on again
13	133 Er	When the electric current overflow of the IPM stops	• Turn the power off and on again before using it.
14	135 Er	High-voltage error	• Power-off and input power check • Check the brake resistance and the fuse - use after replacement
15	140 Er	Initial current sensing error	• Check the setting value of the initial current sensing
16	200 Er	Motor load factor excess error	• Check the motor load

HOW TO PLACE FOR CONTROLLER

S4AC50 - [] [] [] - [] [] []

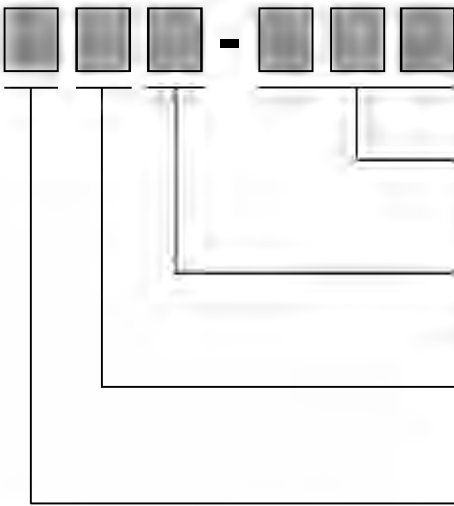

- a : Sub classification according the details of the medal
- b : Distinction of the SunStar models from others
- E : Economic Type
- F : Full Option Type
- A : Sunstar KM-2300 Series, 235A/B, 250A/B ...
- D : SunStar SC-7300 Series ... (Chain Stitch)
- 1 : 1Phase 110[V]
- 2 : 1Phase 220[V]
- 3 : 3Phase 220[V]

S4AC75 - [] **A** → [] [] []

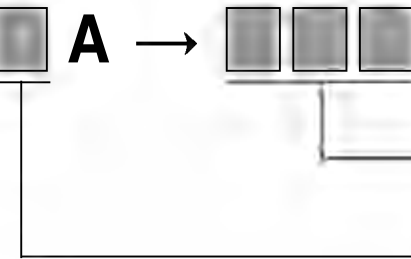

- Group B Number(Sub codes)
- 1 1-phase 110V
- 2 1-phase 220V
- 3 3-phase 220V

S4AC55 - [] **J F 36** → **KM-360J-7M** (Hemming S/M, Mechanical Type)

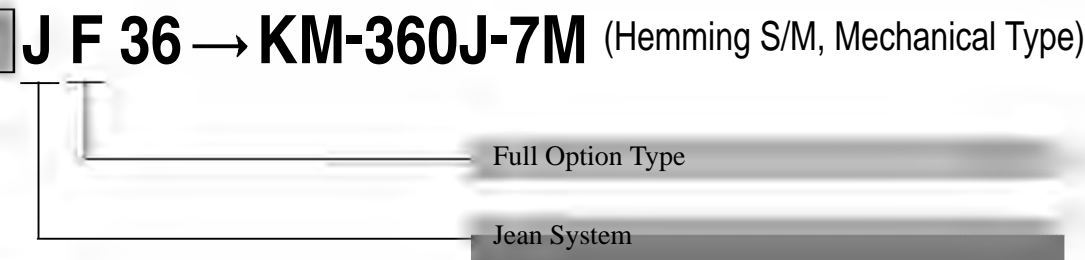

- Full Option Type
- Jean System

S4AC55 - [] **J E 82** → **SC8200J** (Feed-off-the-Arm)

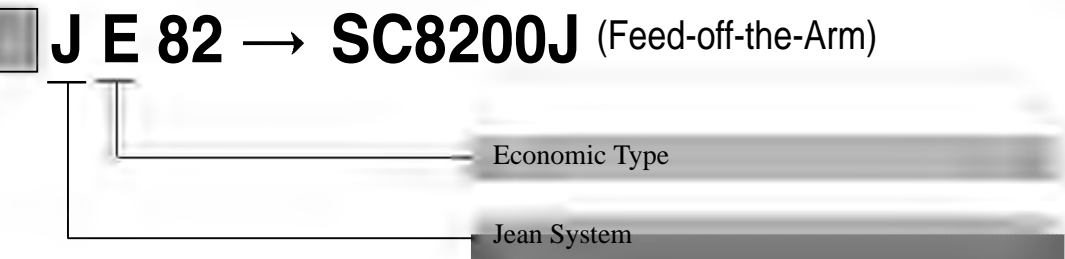

- Economic Type
- Jean System

ORDER Ex. S4AC50-2AF refers to SERIES4, 1Phase 220V, FULL FUNCTION CONTROL BOX for normal drop feed.

BLOCK DIAGRAM

FORTUNA SERIES 4 BLOCK DIAGRAM

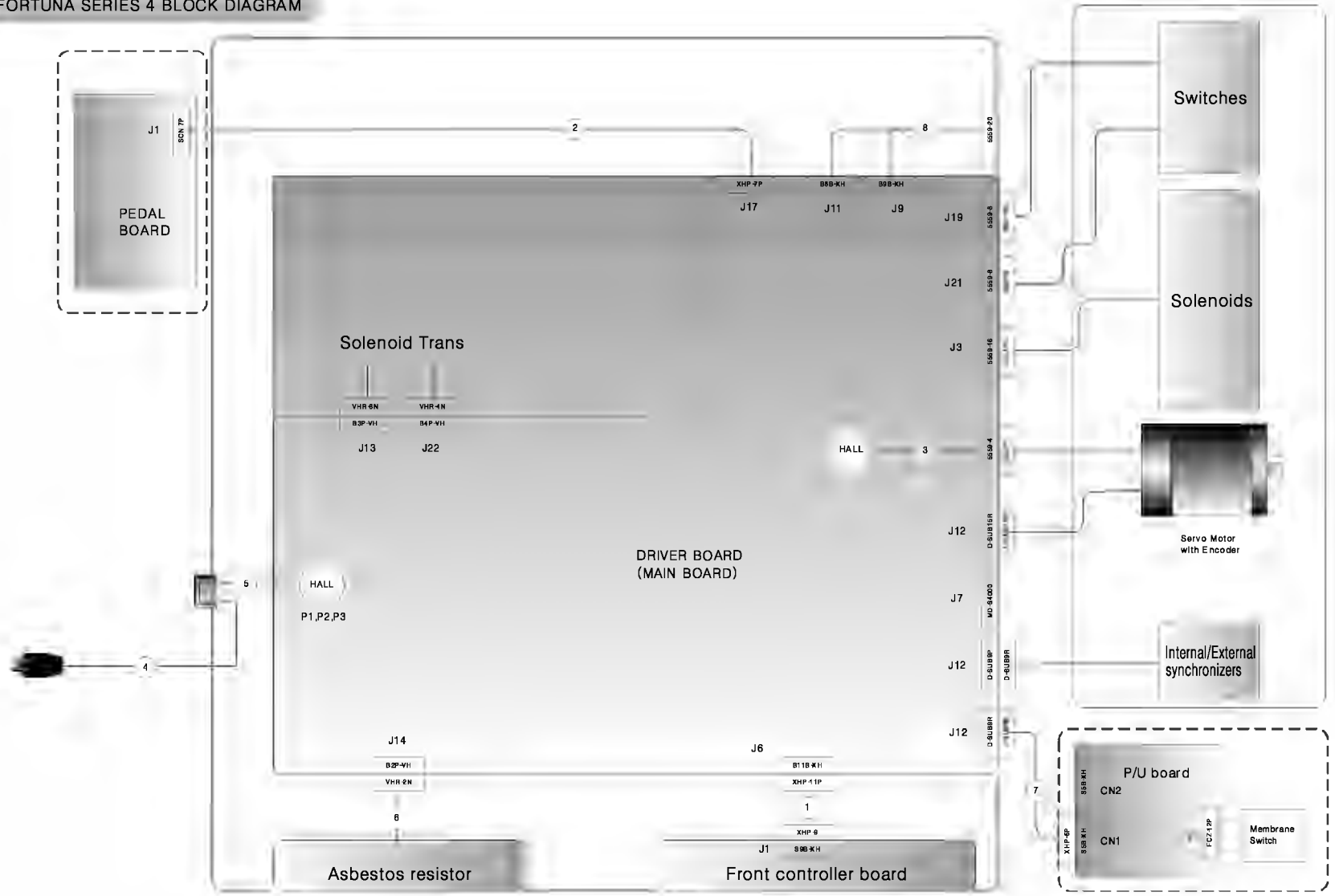

MANUAL CODE NO.
SIVK001-04



Fortuna IV 750W USER'S MANUAL

1

PRECAUTIONS BEFORE USE

1. Do not turn on the power while stepping on the pedal.

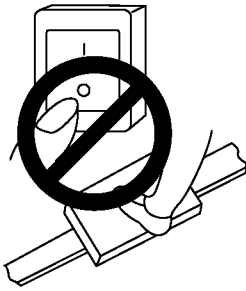

2. Turn off the power when leaving the servomotor overnight.

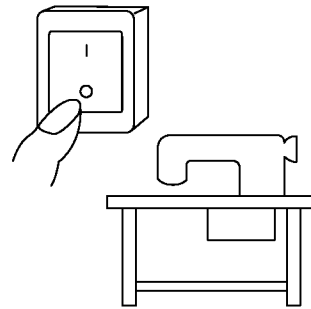

3. Turn off the power when servicing the servomotor or changing the needle.

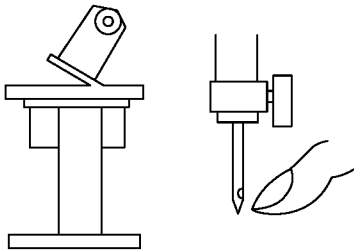

4. Be sure to keep the servomotor securely grounded.

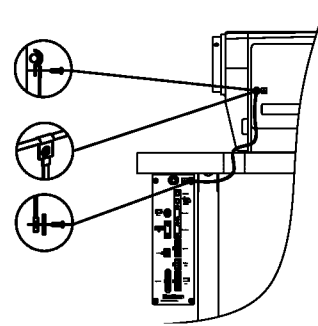

5. Do not connect multiple servomotor power plugs to the same power strip.

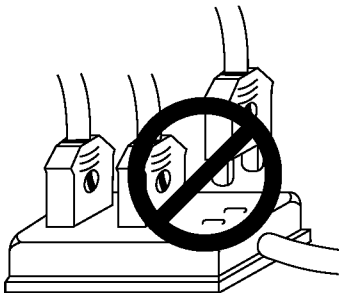

6. Install the servomotor away from noise sources, such as high-frequency equipments and welding machines.

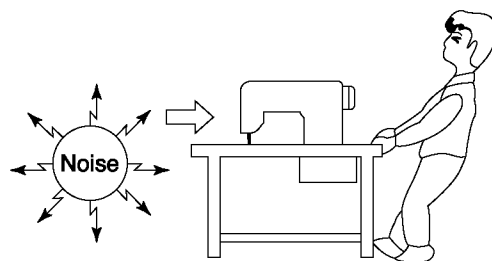

7. Avoid electrical shock when servicing the controller box. (Wait for 6 minutes before opening the cover after turning off the power.)

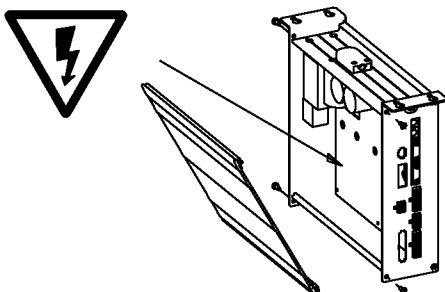

8. When an error message "Er" appears on the digital display, take a note of the "Er" code, and then turn on and off before resuming operation (Contact the local dealer if "Er" message persists on the display)



9. Clean it every two or three weeks so that no dirt or a dirty substance may be piled up.

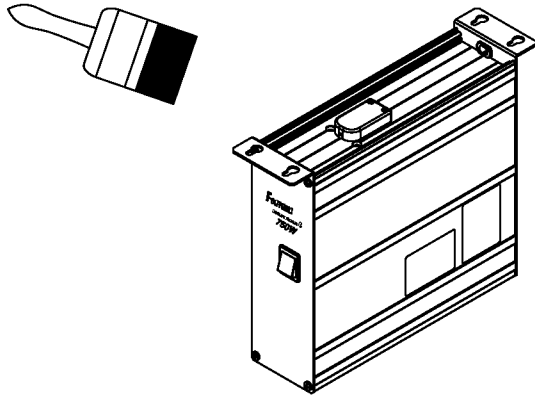

10. When replacing the fuse, use a standard item, opening the cover as shown in the diagram.

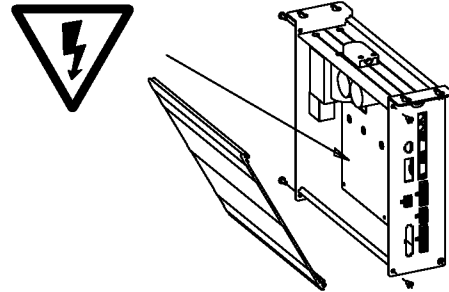

F1	250V/15A [65TL/31.8mm]
F2	250V/15A [65TL/31.8mm]
F3	250V/1A [50T/20mm]
F4	250V/6.3A [50T/20mm]

11. Make the length of the cable connected with an outside parts like stand-up pedal as short as possible.

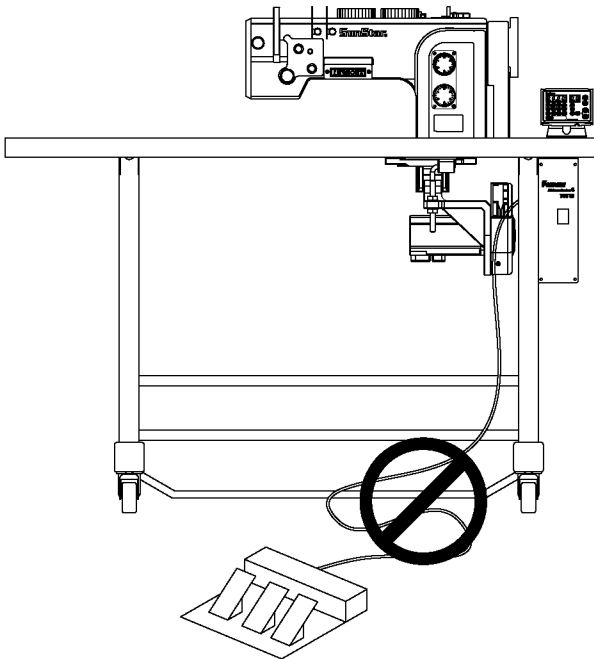

12. Adjust the belt tension to the optimum level.

Belt-tension adjustment should be performed after the motor is mounted on the table : First, loosen both the upper and lower anchoring bolts (1, 2). The belt tension will then be adjusted by the weight of servo motor itself. Fasten both anchoring bolts.

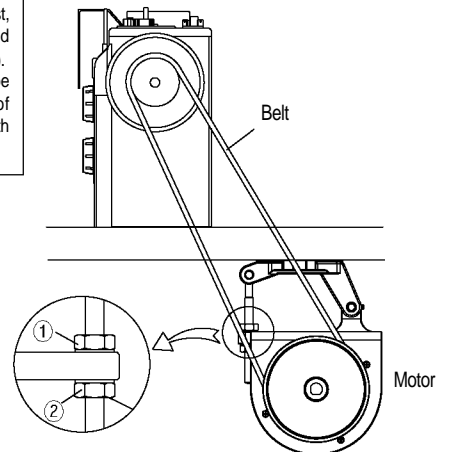

2

LOCATING AND USING PARTS OF THE CONTROLLER BOX

1) Front and back of control box

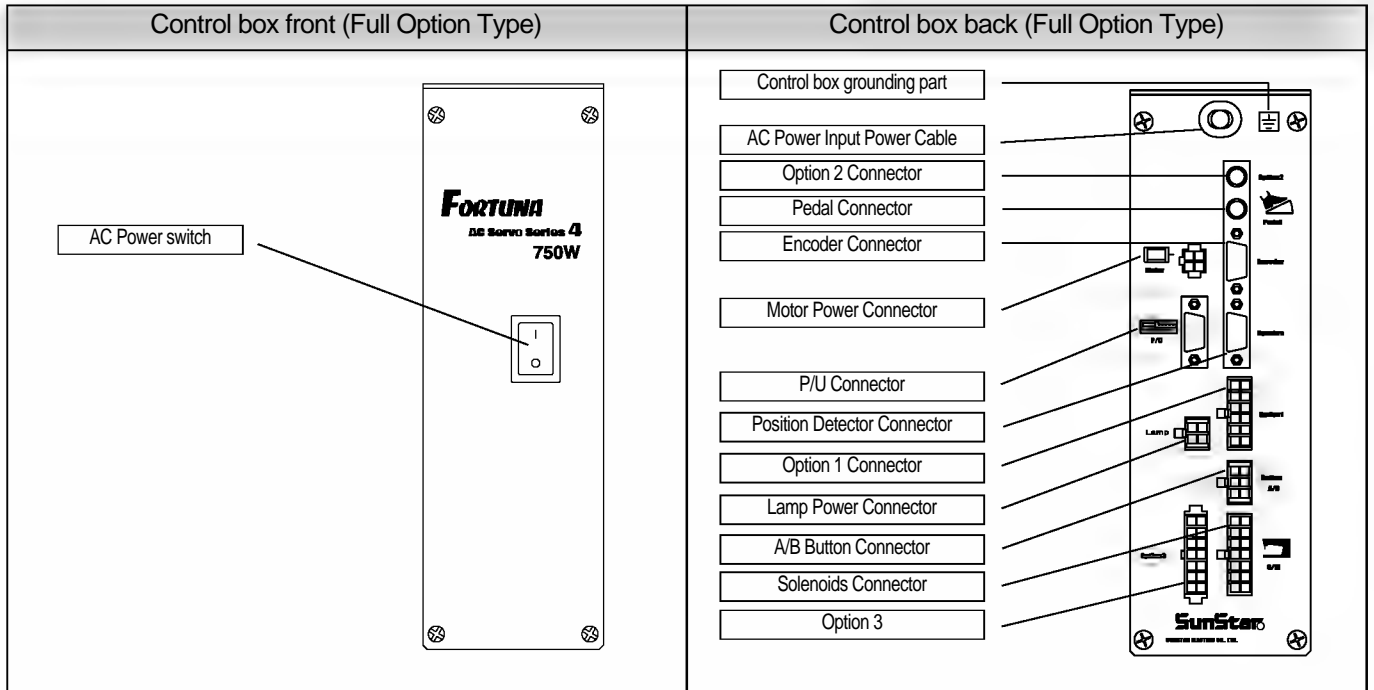

2) Control box side

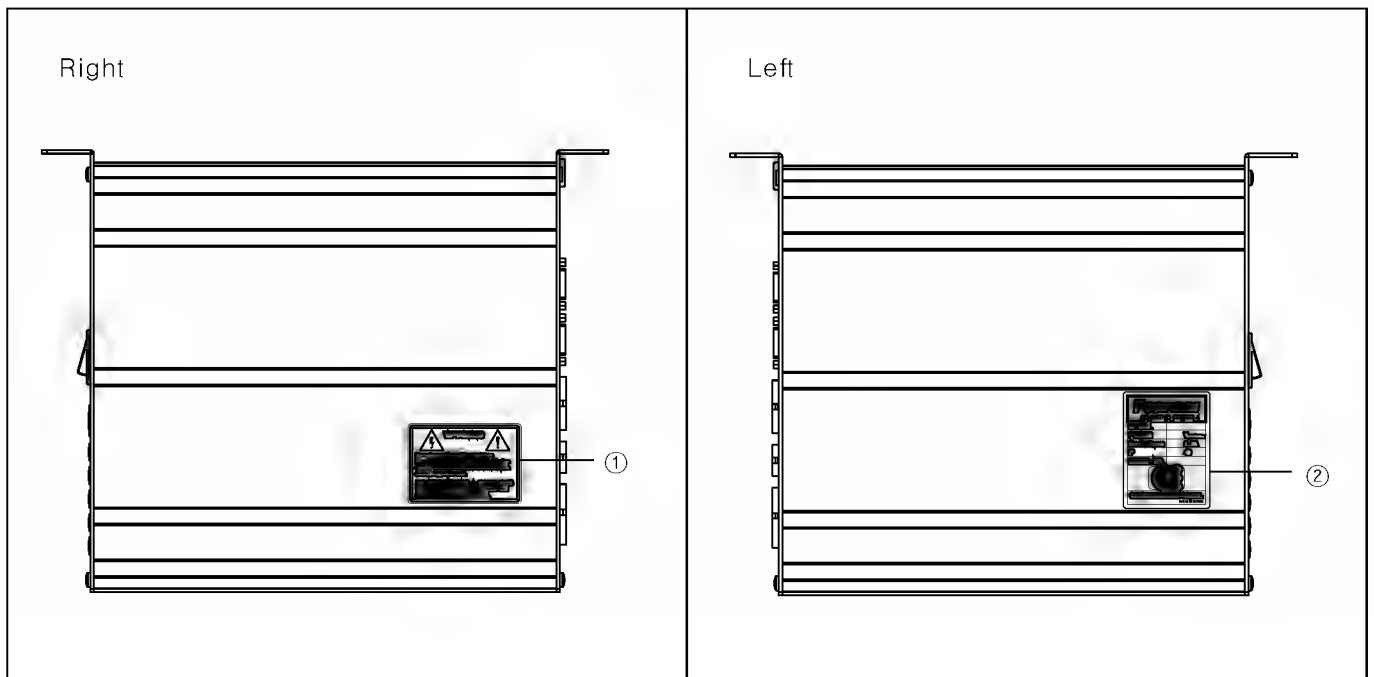

① Caution



WARNING
경 고



Hazardous voltage will cause injury.
Be sure to wait at least 360 seconds before opening this cover after turn off main switch and unplug power cord.

고압 전류에 의해 감전될 수 있으므로 커버를 열 때는 전원을 내리고 전원 플러그를 뽑고 나서 360초간 기다린 후 여십시오.

② Specification

FORTUNA
AC SERVO SERIES 4 750W

MODOL	
POWER	V _r 50/60Hz
Current(MAX)	5.0A
IP	40
SERIAL NO.	



SUNSTAR MACHINERY CO.,LTD.
MADE IN KOREA

3

INSTALLATION

1) Mounting your Servo Motor on the table

- ① Make sure that the holes are bored on the table as shown in the figure.

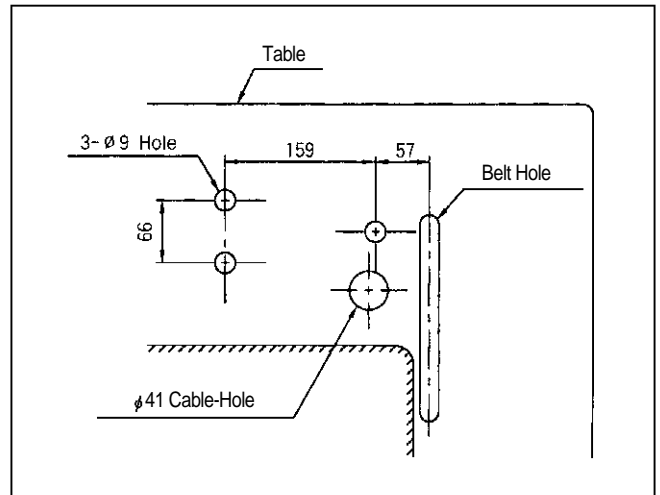

- ② Insert three motor-fixing bolts through the three holes on the table. Attach the motor base padded with vibration-proof rubber, and slide flat and spring washers over the bolt stems, and then fasten the bolts with nuts.

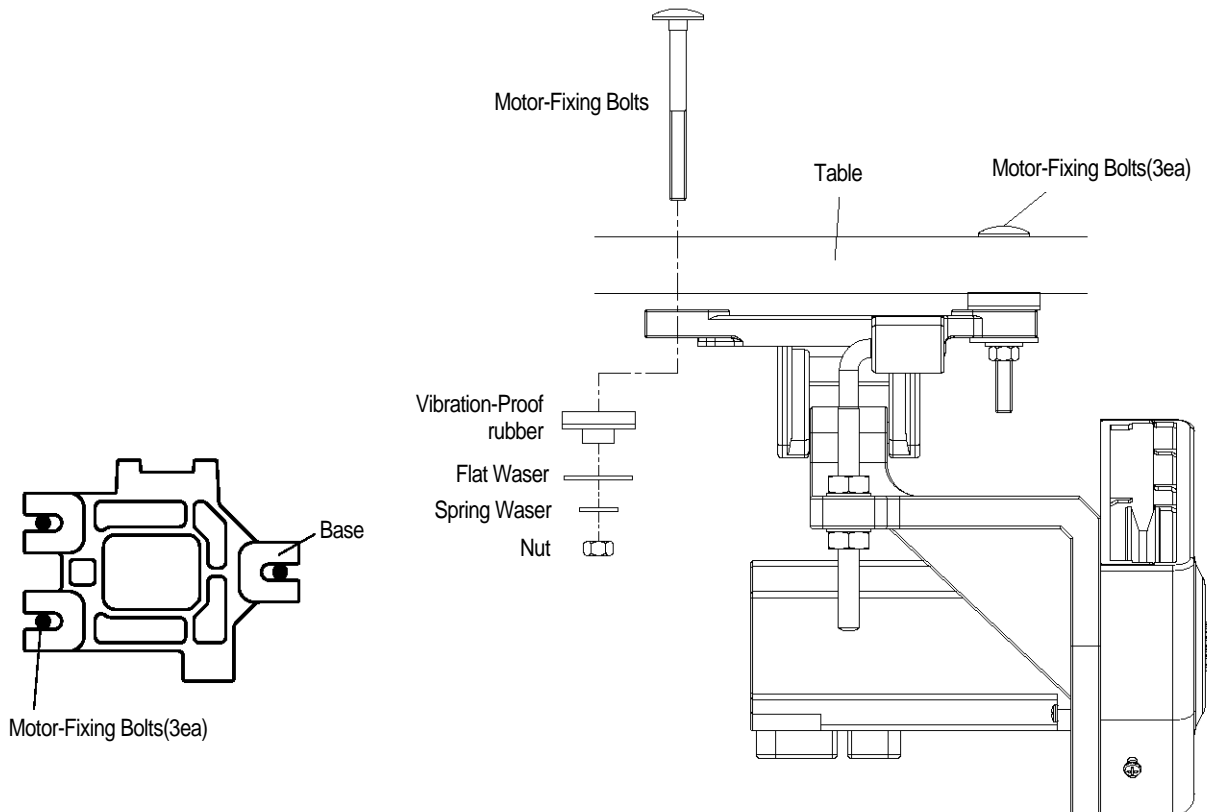

- ③ Make sure that the center of motor pulley is matched to that of the sewing machine before tightening the motor-fixing bolts and nuts.

2) Assembling the belt cover and adjusting the belt tension

(1) Belt cover assembling procedure

① Upon the completion of the motor mounting, bring the two pulleys of motor and sewing machine closer to each other, by pulling back the sewing machine. You can then mount the belt easily as shown in the figure.

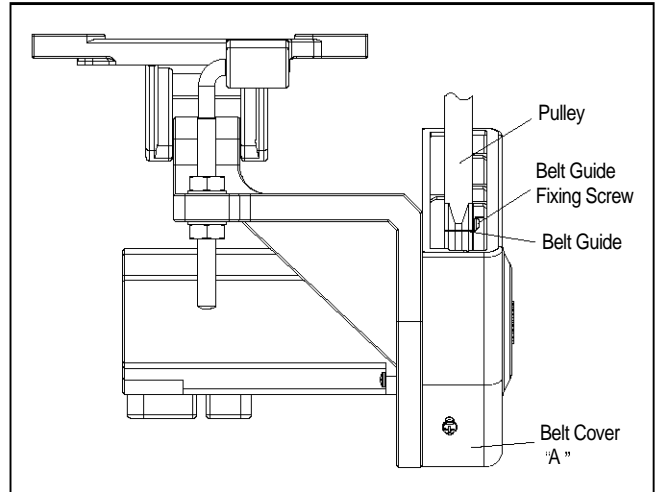

② Place the belt cover 'B', making sure that the belt cover does not contact the belt, and then fasten the cover with the fixing screw.

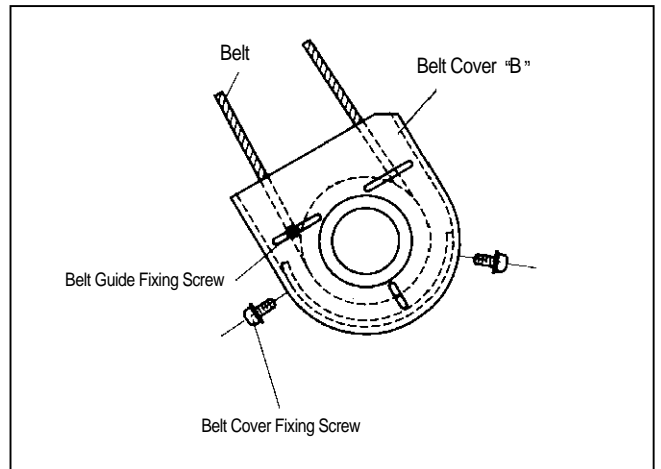

(2) Adjusting the belt tension

① Optimum Tension Level : The optimum tension level is achieved when the belt is pushed by 5-10mm when the top surface portion of the belt at about 30-50mm above the tabletip is pressed by a finger with a force of $\sim 1 \text{ kgm/sec}^2$ or 1 Newton.

② Adjusting the Tension Level : If the tension level is out of the optimum range, adjust the tension as follows. First, loosen both the upper and lower nuts for the anchor bolt, letting the belt be stretched by the motor weight itself. Second, tighten the upper nut only to the extent that the motor does not move. Third, fasten the bottom nut tightly so that the motor is securely fixed.

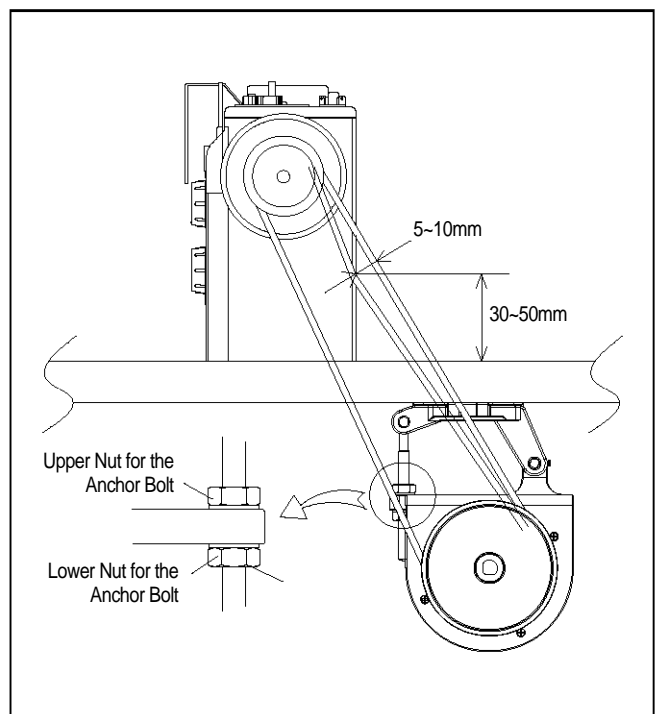

3) Attaching controller to table

① As in the figure, attach control box to the lower right of the table with 15mm fixing screws.

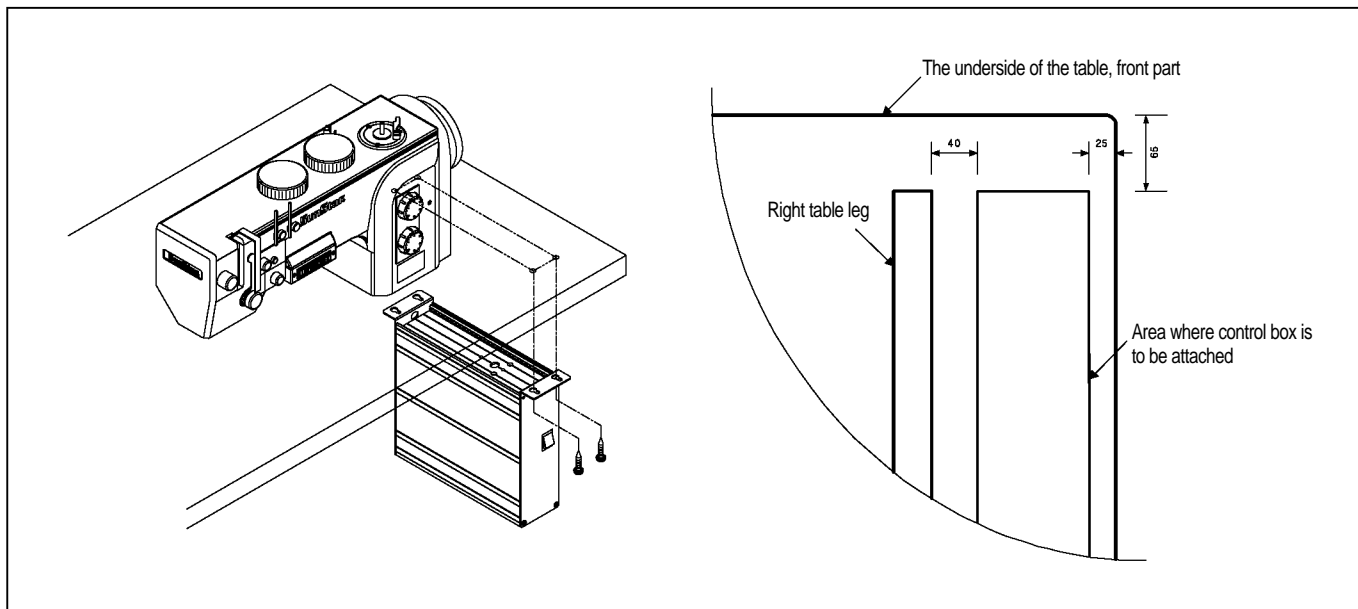

4) Attaching pedal unit

① As in the figure, attach pedal unit bracket to the underside of table with 15mm fixing screws.

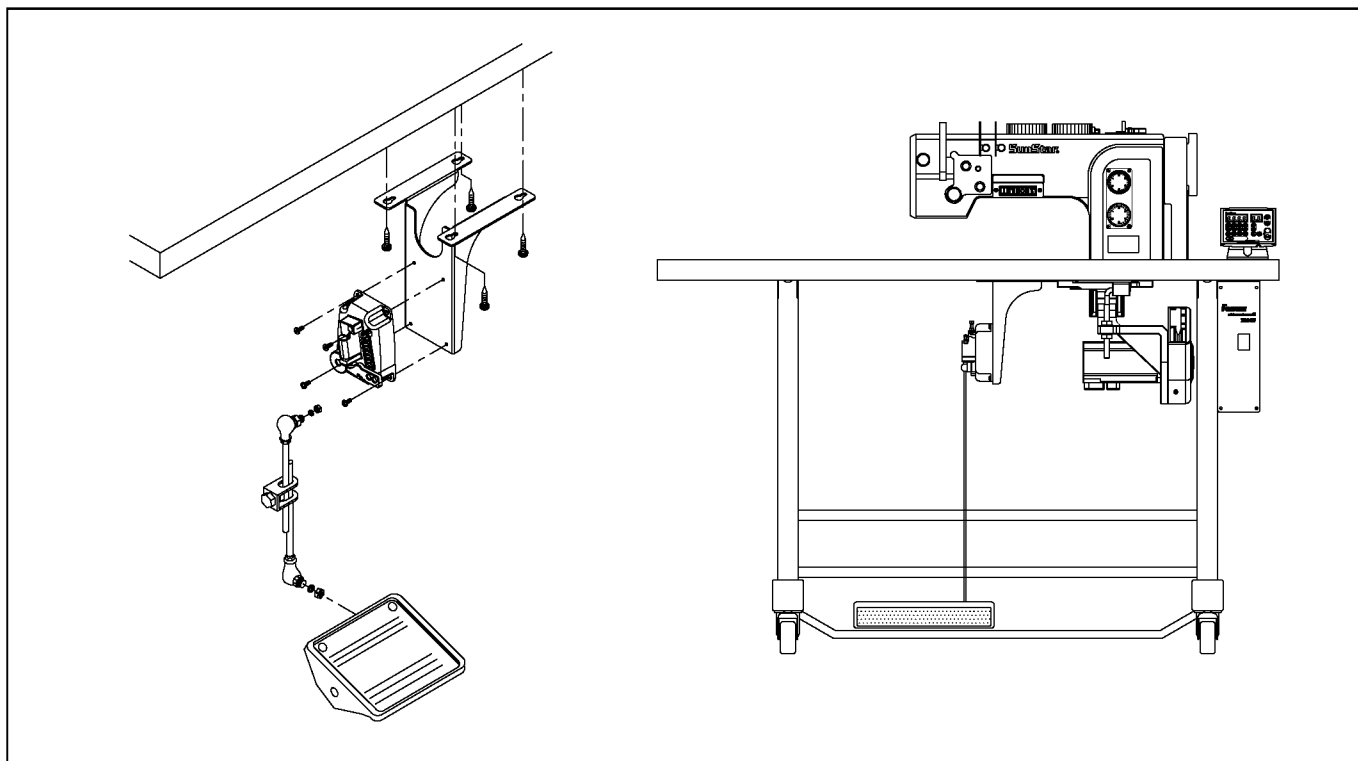

② Attach pedal unit to the fixing holes on one side of pedal unit bracket.

③ Pedal unit bracket should be fixed to the area where the bar linked to the pedal that is to be attached to table leg becomes vertical.
(The area where pedal unit bracket is attached depends on where the pedal is.)

5) Installation of full function program unit

(1) SunStar KM-235 Sewing Machine

First, attach the P/U bracket to the P/U using three fixing screws and a supporting bolt with nut attached on it as shown in the figure. Second, securely attach the P/U to the head of the sewing machine using two fixing screws and washers, keeping a 3~4mm distance between the bottom surface of the nut and the base of the supporting bolt.

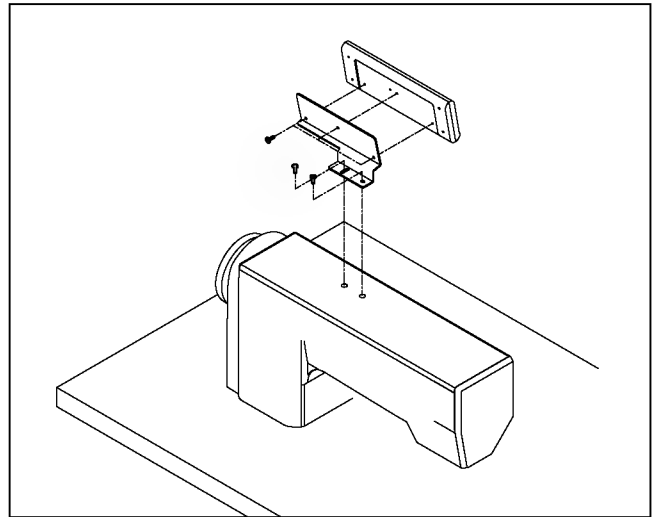

(2) Other SunStar thread-machine

First, attach the P/U bracket to the P/U using the four fixing screws. Second, attach the P/U to the main body of the sewing machine using the three bracket-fixing screws as shown in the figure.

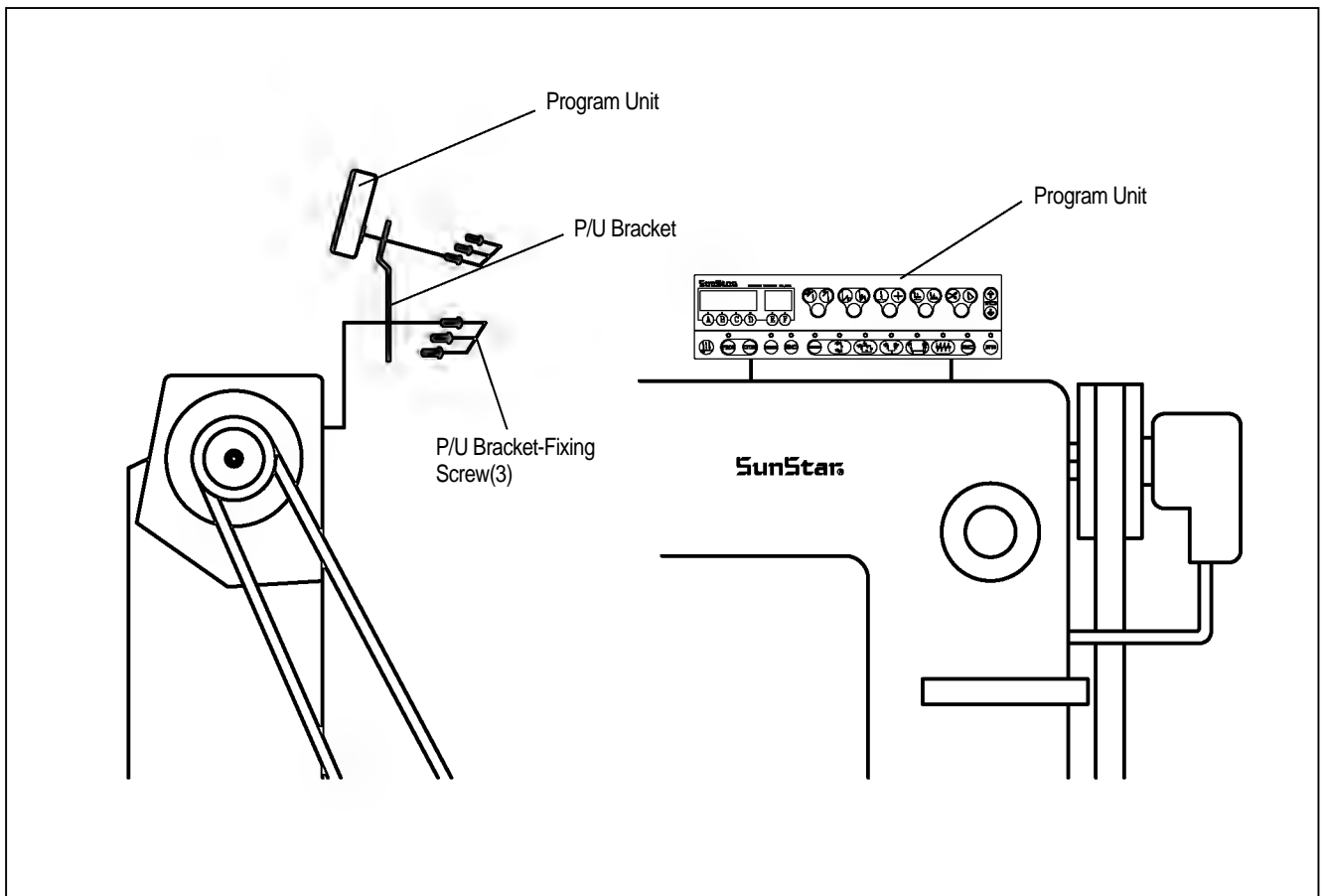

Caution

Fix the cable using the cable tie so that cable is not in the way of the belt.

6) Small-type Program Unit Installation Method

- ① As in the figure below, attach program unit bracket to program unit with three fixing screws. As in the figure, attach the bracket with program unit to the head of machine firmly with two fixing screws.

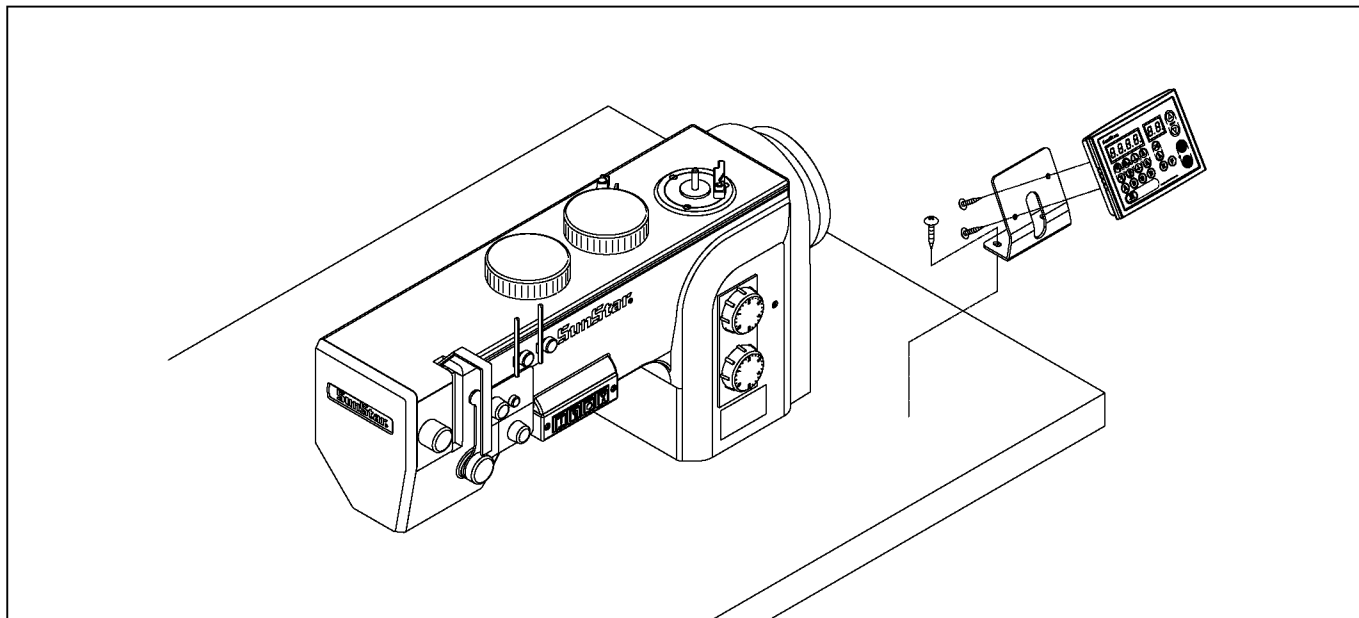

7) SunStar machine installed with program unit

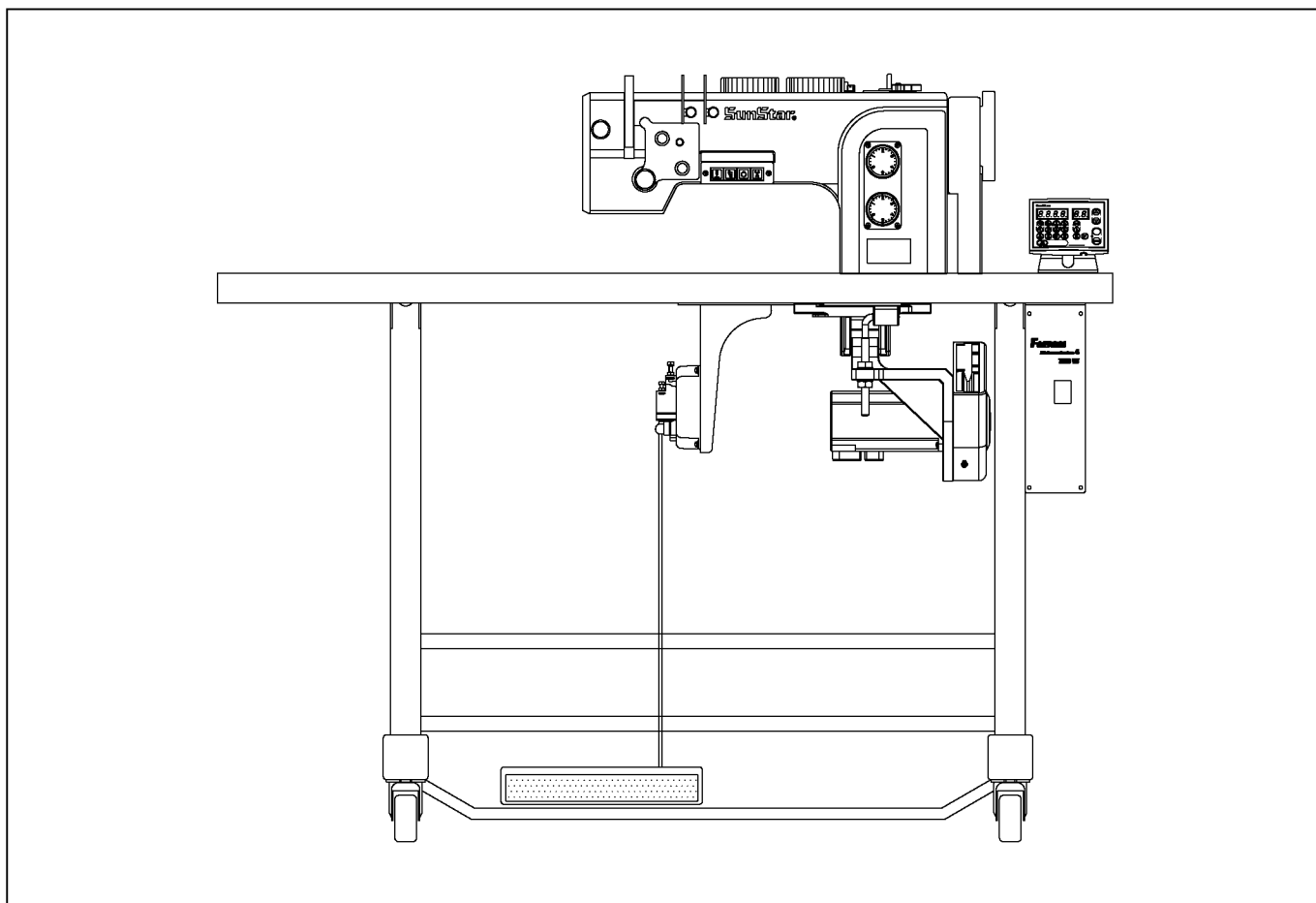

8) Mounting and adjusting the foot-lift solenoid

(1) SunStar KM-235 Model

- ① Attach the main power switch first since the power switch is located normally in between the solenoid brackets.
- ② By referring to the figure on the right and the mounting instructions enclosed in the packaging box, locate the insertion surface of the oil pan, and then attach the foot-lift solenoid.

No.	Solenoid No.	Applicable Models
1	SPF-2	KM-235A, B

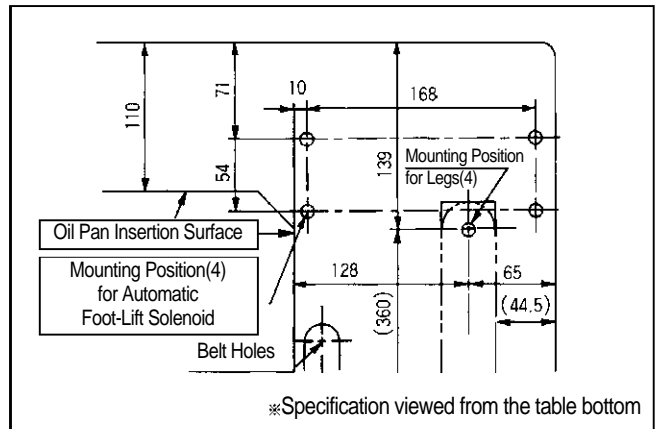

(2) SunStar KM-250 Model

- ① First, assemble a panel for the attachment of presser foot solenoid on the back of KM-250.
- ② Attach the presser foot solenoid to a bracket "A".
- ③ Attach the bracket "A" with the presser foot solenoid to the panel above.
- ④ Attach a crank to a solenoid shaft and then connect it to a sewing machine.
- ⑤ Place a cover on the solenoid.

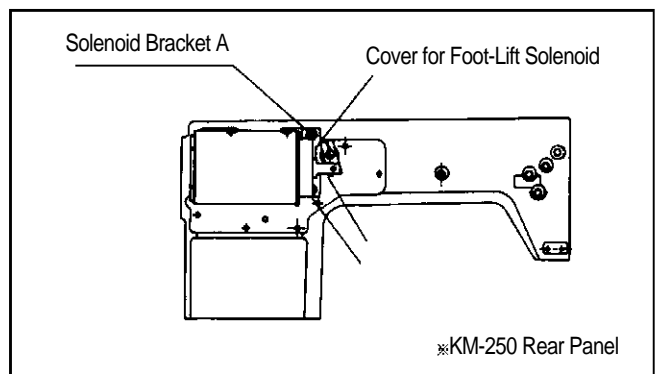

(3) SunStar Special-specification models

The same mounting procedure for KM-235 model is applicable for other models listed below.

No.	Solenoid No.	Applicable Models
1		KM-750-7, KM-750BL-7
2	SPF-3	KM-790-7, KM-790BL-7
3		KM-857-7, KM-867-7
4	SPF-4	KM-560-7
5	SPF-6	KM-957-7, KM-967-7
6	SPF-8	KM-757-7
7	SPF-9	KM-640BL-7

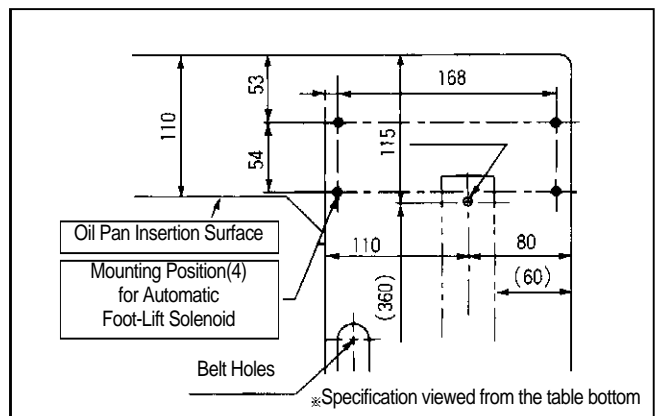

(4) Adjusting the stroke(Gap) of the automatic foot-lift solenoid

① Check point

Check to make sure that the stroke-adjusting screw is located at the center of the solenoid axis, i.e., the solenoid should be assembled in parallel with the bottom surface of the table. If the solenoid is not in parallel, make an adjustment so that the screw is in parallel with the center of the solenoid axis using the connection link-fixing screw.

② Adjusting Procedure

The vertical travel distance of the presser foot can be adjusted by the stroke-adjusting screw. First, Loosen the two fixing screws, and adjust the vertical stroke using the stroke-adjusting screw. loosening and tightening the stroke-adjusting screw will decrease and increase the vertical stroke of the presser foot respectively. After the adjustment, fasten the fixing screw tightly.

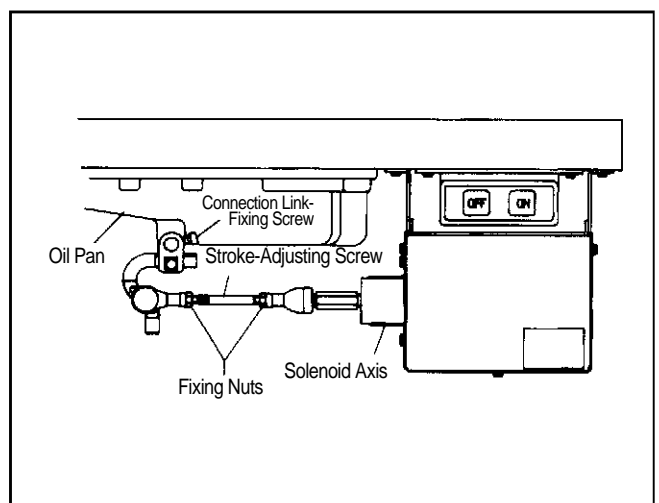

9) Mounting the position sensor (Synchronizer) and setting the film

(1) Mounting the position sensor(Synchronizer)

① SunStar thread-cutting sewing machine.

All SunStar thread-cutting sewing machines are equipped with a position sensor. Users, therefore, are required to adjust the film position, if necessary, as shown in the figure.

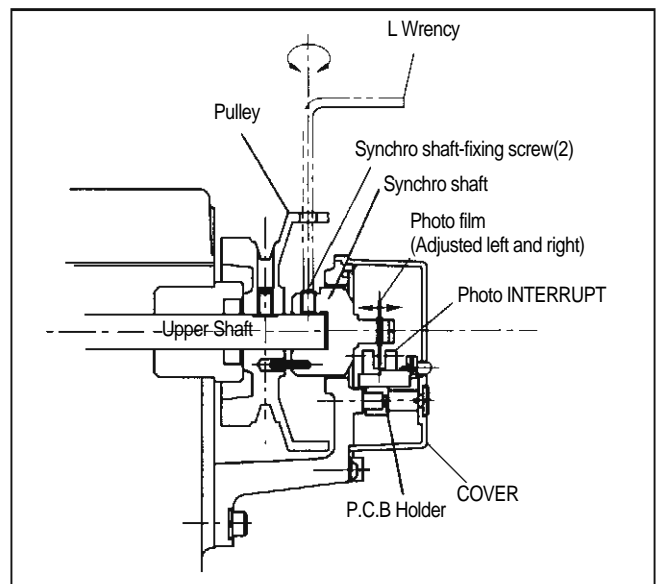

② All other sewing machines(including other manufacturers' brands)

First, attach the position sensor-mounting adapter to the upper shaft of the sewing machine. Second, attach the position sensor-fixing plate to the body of the sewing machine as shown below in the figure. Third, secure the position sensor to the adapter with the fixing screws.

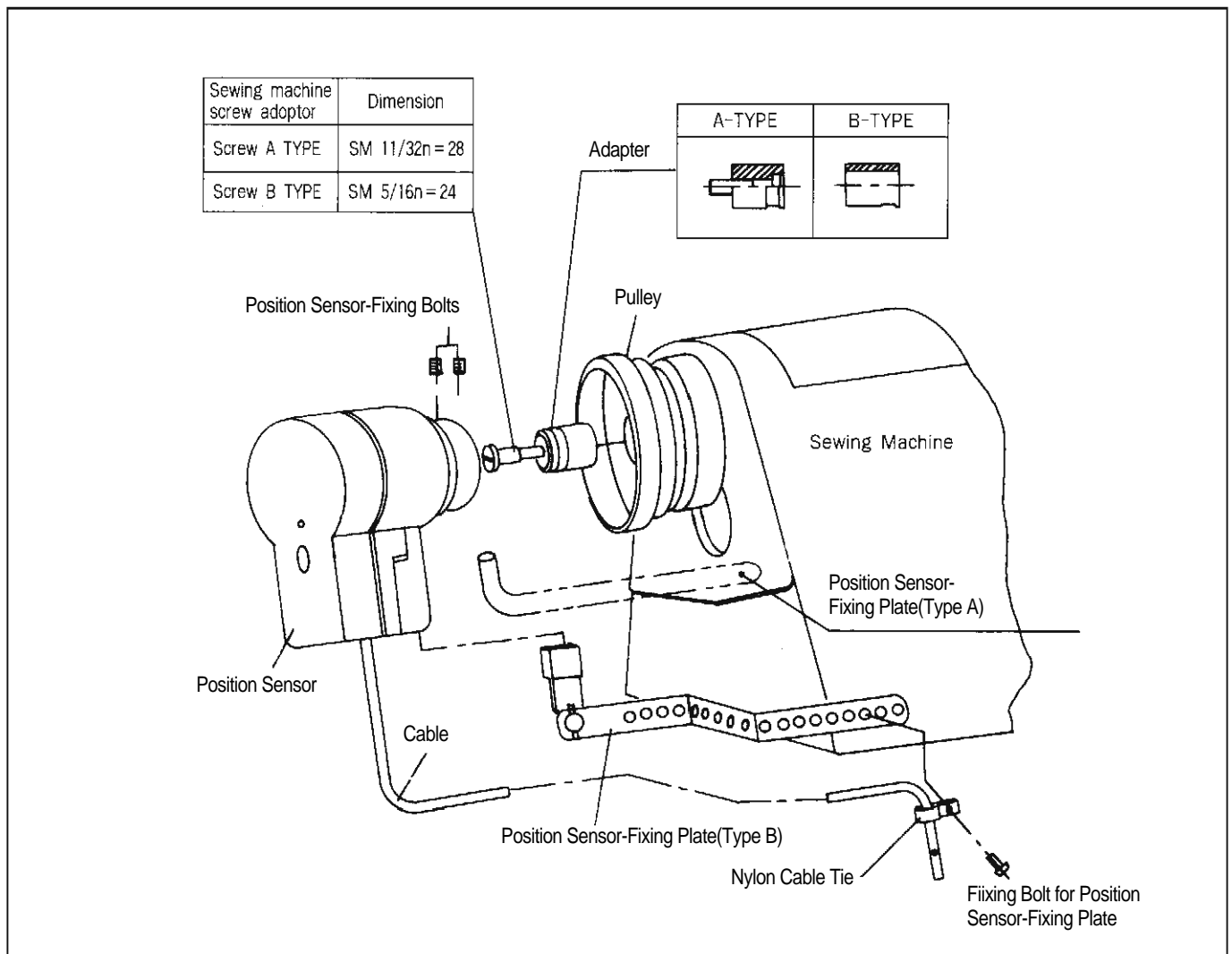

(2) Adjusting the film of the position sensor

① Assemble the films and position sensor in the order as shown in the figure.

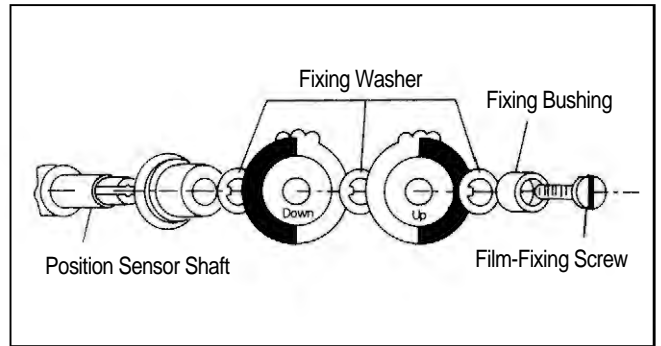

② Upon the completion of the assembling, position the needle shaft tight at the rising point from the lowest needle position by manually rotating the pulley. Loosen the film-fixing screw, and adjust the DOWN film so that the film-adjusting line and the sensor housing calibration line are matched. Tighten the film-fixing screw just to the extent that the film can not be rotated. Likewise, position the thread take-up at the highest position. Loosen the film-fixing screw, and adjust the UP film as shown in the figure, while using caution not to move the DOWN film which is already adjusted earlier. Tighten the adjusted film with the fixing screw.

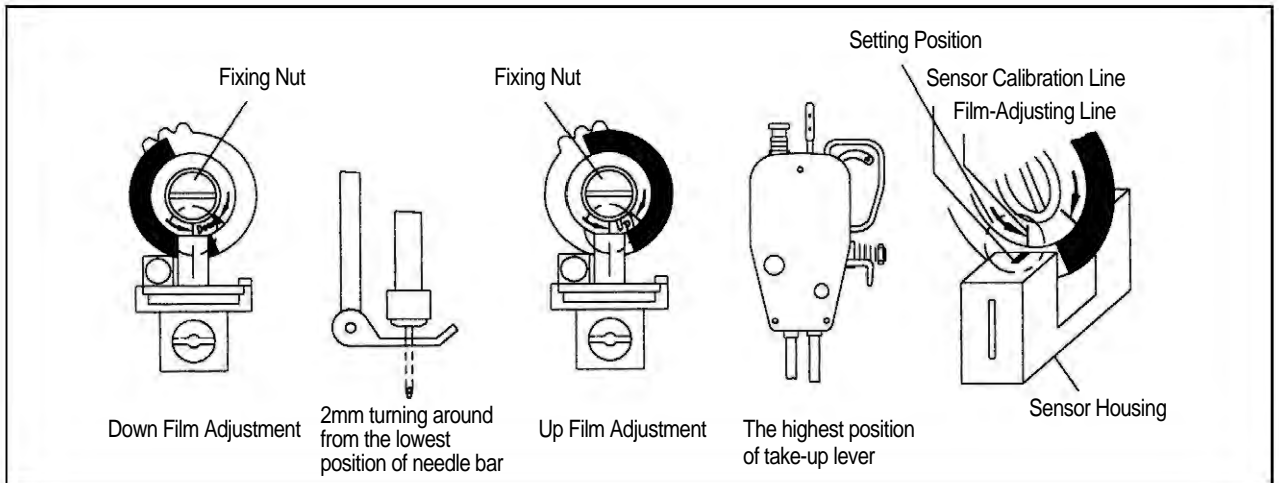

(3) Adjustment the films of reverse rotation sewing machines

※ For reverse-rotation sewing machines, the film-adjusting lines located at right edge of the "UP" and "DOWN" film should be matched to the center line of the sensor.

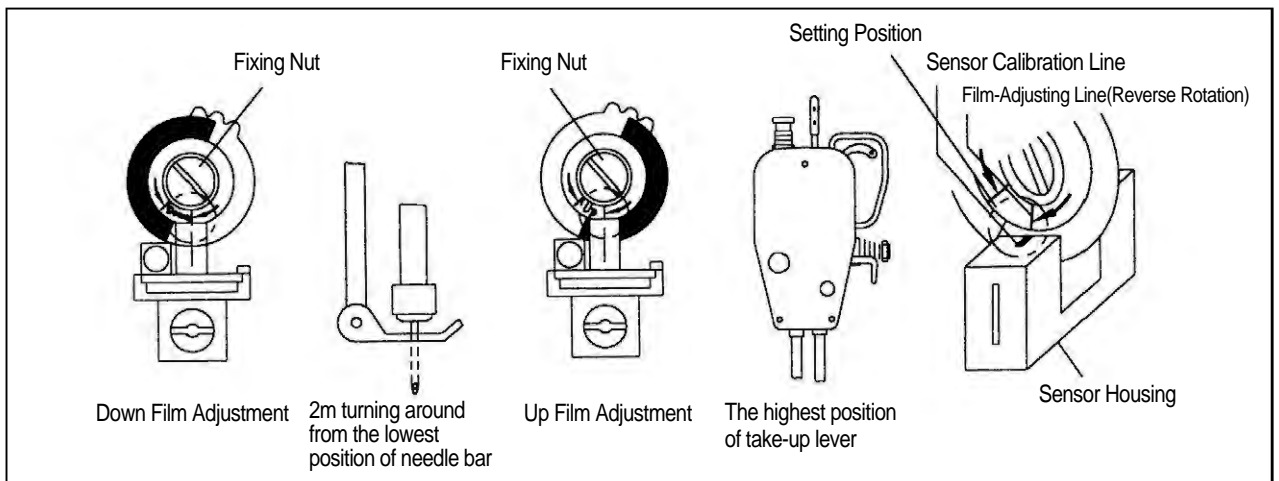

Caution

After adjustment the film of the position detector, be sure to rotate the motor for 3~5 seconds by pedalling so that the Controller may remember location of the film.

10) How to equip and adjust a built-in location detector(synchronizer)

(1) How to equip the built-in location detector (synchronizer)

► In case of a SunStar thread trimmer

When a built-in location detector(synchronizer) for the sewing machine with the SunStar thread trimmer is equipped, all that the users need to do is to simply adjust the location of magnetic for detection according to their needs.

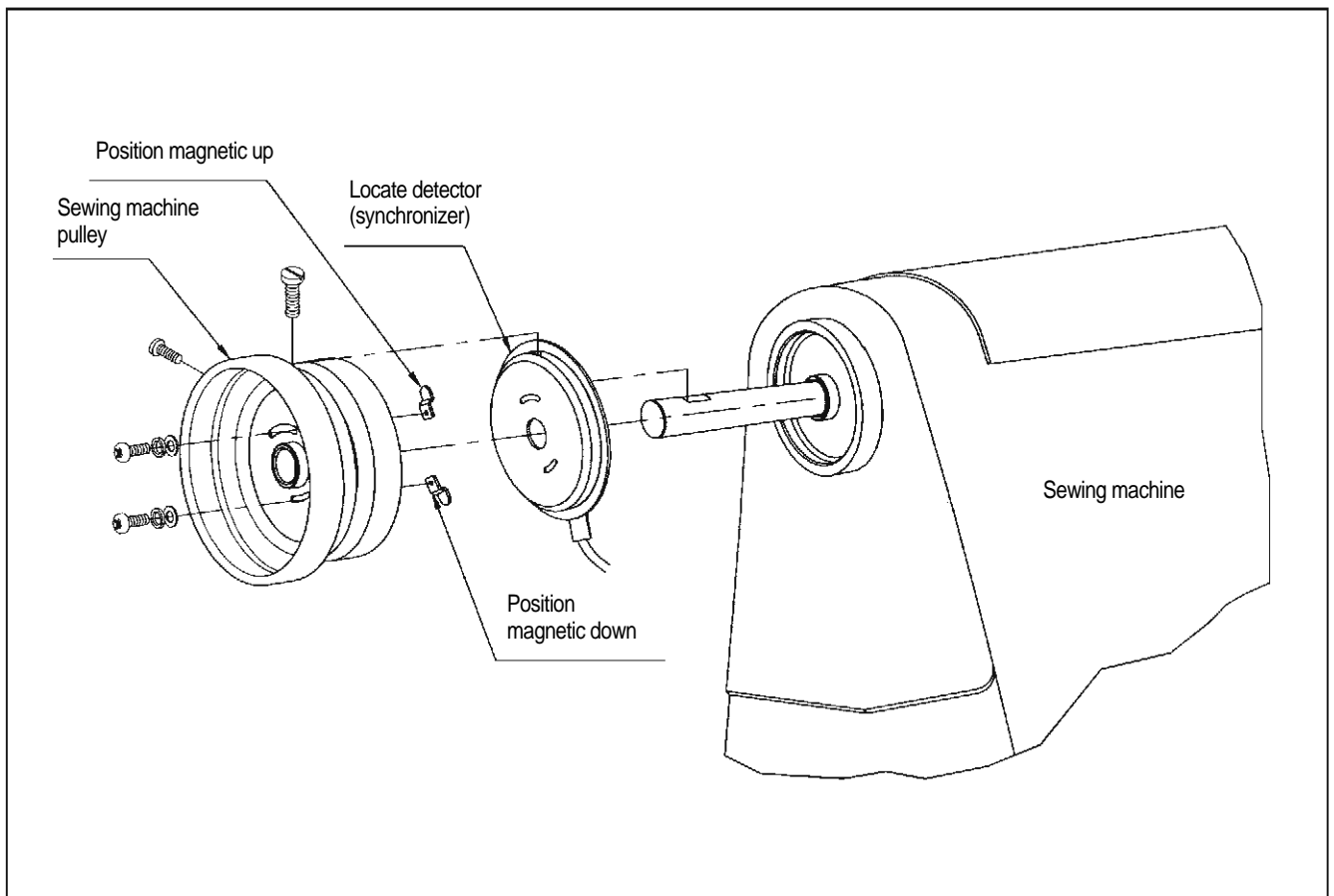
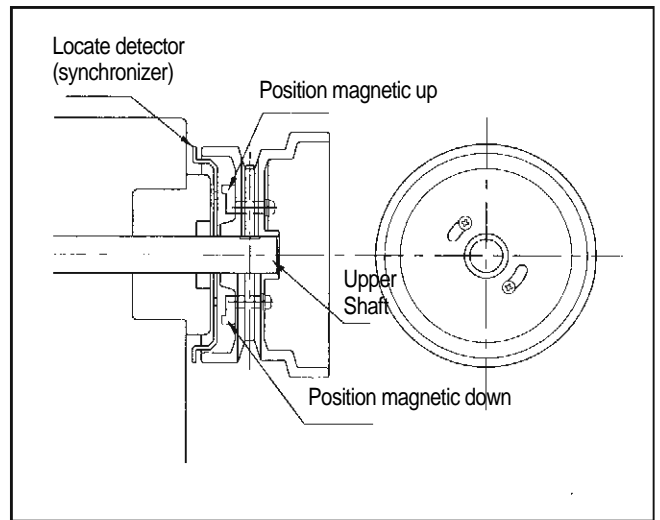

(2) How to adjust the magnet of the location detector

① Assemble the detector in order following the pictures.

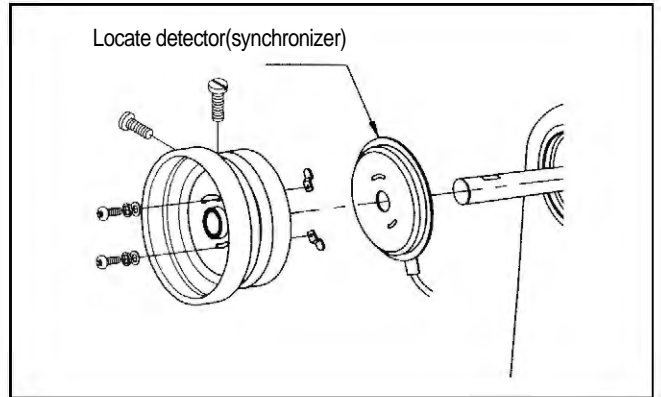

② Once assembling is completed, power the controller on and step on the pedal. At this time, make sure that the needle moves up and down. Stop the needle at a desired location by moving the magnet back and forth along the location where the needle stops.

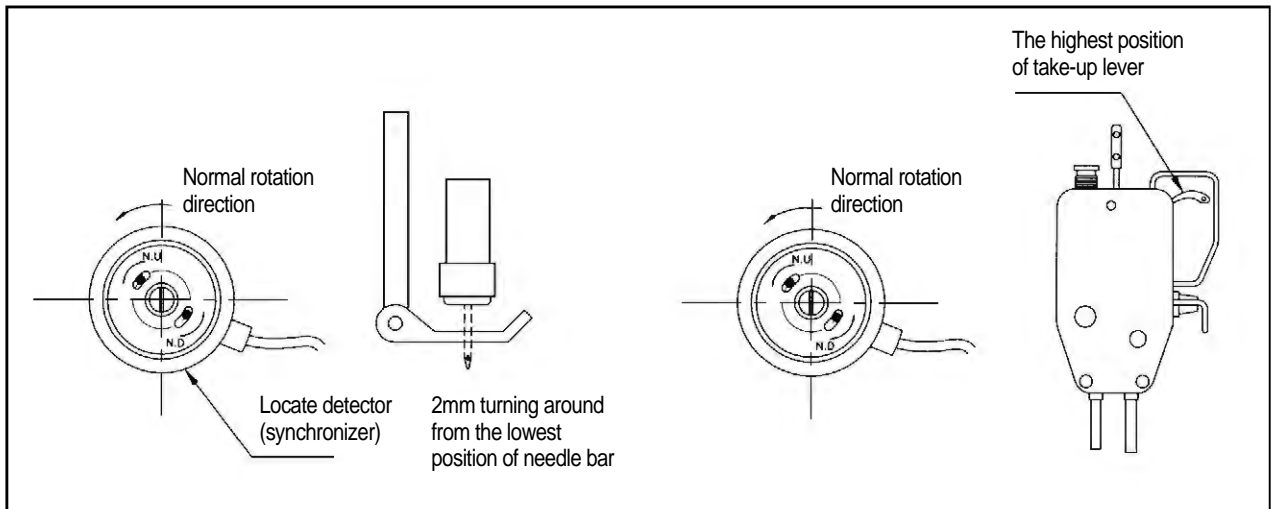

(3) How to adjust a location detector in case of a reverse rotation sewing machine

※ It is the same as that used for the normal rotation direction

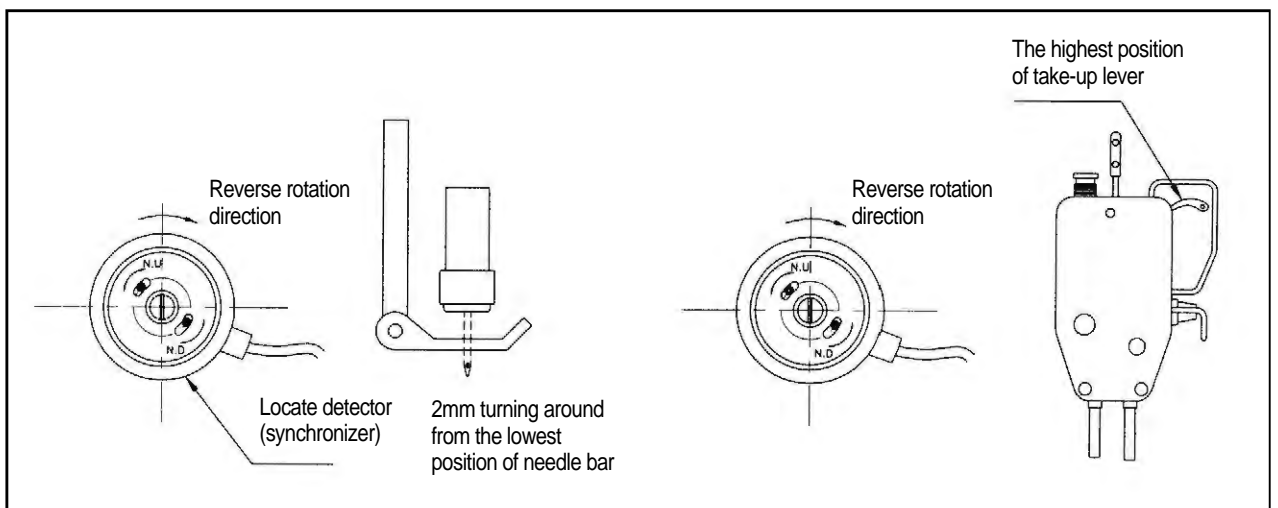

Caution

After adjusting a location detector, rotate the motor by stepping on the pedal for 3~5 seconds so that a controller can remember the location.

4

WIRING AND GROUNDING

1) Specification of the power plug

(1) Single phase 100V~120V

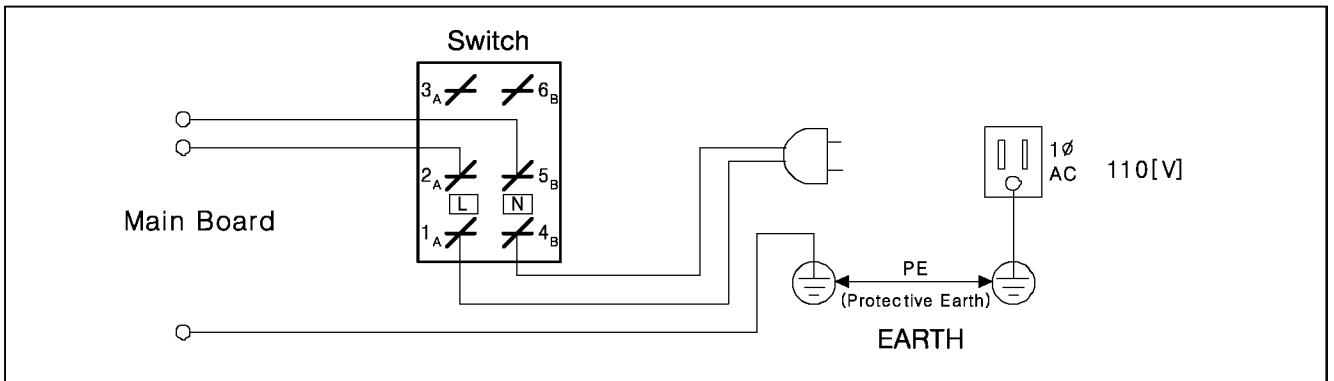

(2) Single phase 200V~240V

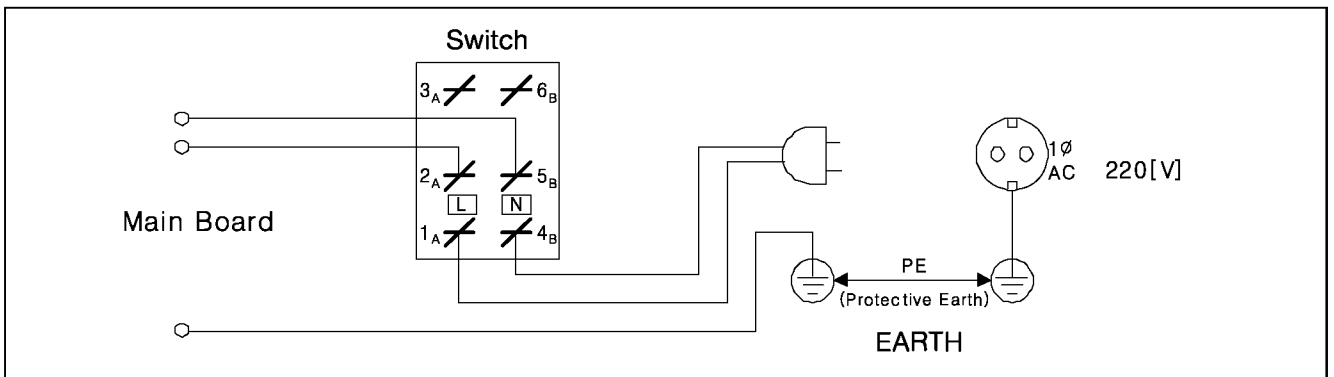

(3) Three phase 200V~240V

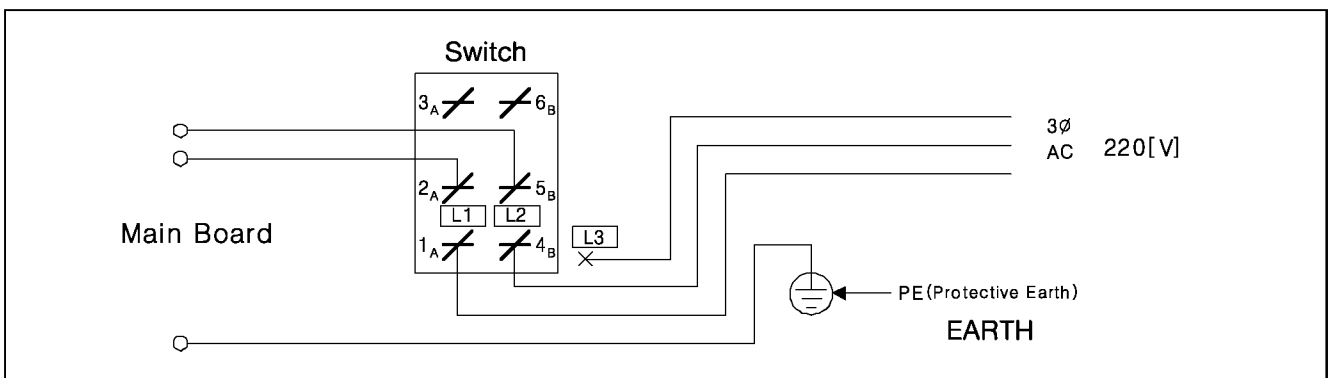

※ Be sure to connect Protective Earth

2) Specification of electric current in wiring of power plug

Be sure to use wiring materials which can stand electric current of higher than 15A.

3) Names and Explanation of external connector in control box

① Solenoid Connector (5566-16P)

[Pin Number]							
16	15	14	13	12	11	10	9
8	7	6	5	4	3	2	1

1, 9: Back Tack solenoid 2,10: knee lifter solenoid 3,11: Trimming solenoid 4,12: Wiper solenoid	5,13: Left needle control solenoid 6,14: Right needle control solenoid 7,15: Thread release solenoid 8,16: Auxiliary solenoid
---	--

② Basic switch connector (5566-8P)

[Pin Number]			
8	7	6	5
4	3	2	1

1,5: Manual Back tack button A 2,6: Back tack Insert/Delete Button B	3,7: Knee lifter solenoid switch 4,8: Safety Switch
---	--

③ Switch and lamp connector (5566-14P)

[Pin Number]						
14	13	12	11	10	9	8
7	6	5	4	3	2	1

1, 2, 7 : GND 3 : Left switch LED 4 : Right switch LED 5 : Left switch 6 : Right switch 8 : VCC (5[V])	9 : 4/4 10 : 3/4 11 : 2/4 12 : 1/4 13 : Switch-HALF 14 : Switch-CNT
---	--

④ Extension connector (5566-20P)

: When the option board for extension port is not applied

[Pin Number]									
20	19	18	17	16	15	14	13	12	11
10	9	8	7	6	5	4	3	2	1

9, 10 : 12[V] 1~6 : GND 7, 8, 17~20 : VCC (5[V])	11 : Output 12 12 : Output 13 13 : Output 14 14 : Output 15 15 : External Input 00
--	--

⑤ Extension connector (5566-20P)

: When the option board for extension port is applied (BD-000714)

[Pin Number]									
20	19	18	17	16	15	14	13	12	11
10	9	8	7	6	5	4	3	2	1

9, 2, 7~10 : GND 3~6 : +48[V] 11 : Output 12 12 : Output 13	13 : EXI 00 12 : Output 15 13 : Output 14 17, 18 : +5[V] 19, 20 : +12[V]
--	--

4) Changing solenoid supply voltage (Basic setting values upon shipment: J19)

※ It is for a good operation of solenoid when AC input voltage changes.

① Setting values of solenoid supply voltage against input voltage (input voltage 220V series)

Solenoid with the rating current of 30V

Input Voltage	Setting Values
Less than 210V	J20
210V~230V	J19
More than 230V	J18

Solenoid with the rating current of 24V

Input Voltage	Setting Values
Less than 180V	J20
180V~190V	J19
More than 190V	J18

② Setting values of supplied voltage to solenoid against input voltage (Input voltage: 110V)

Solenoid with rating current of 30V

Input Voltage	Setting Values
Less than 100V	J20
100V~120V	J19
More than 120V	J18

Solenoid with rating current of 24V

Input Voltage	Setting Values
Less than 90V	J20
90V~100V	J19
More than 100V	J18

③ Setting supplied voltage

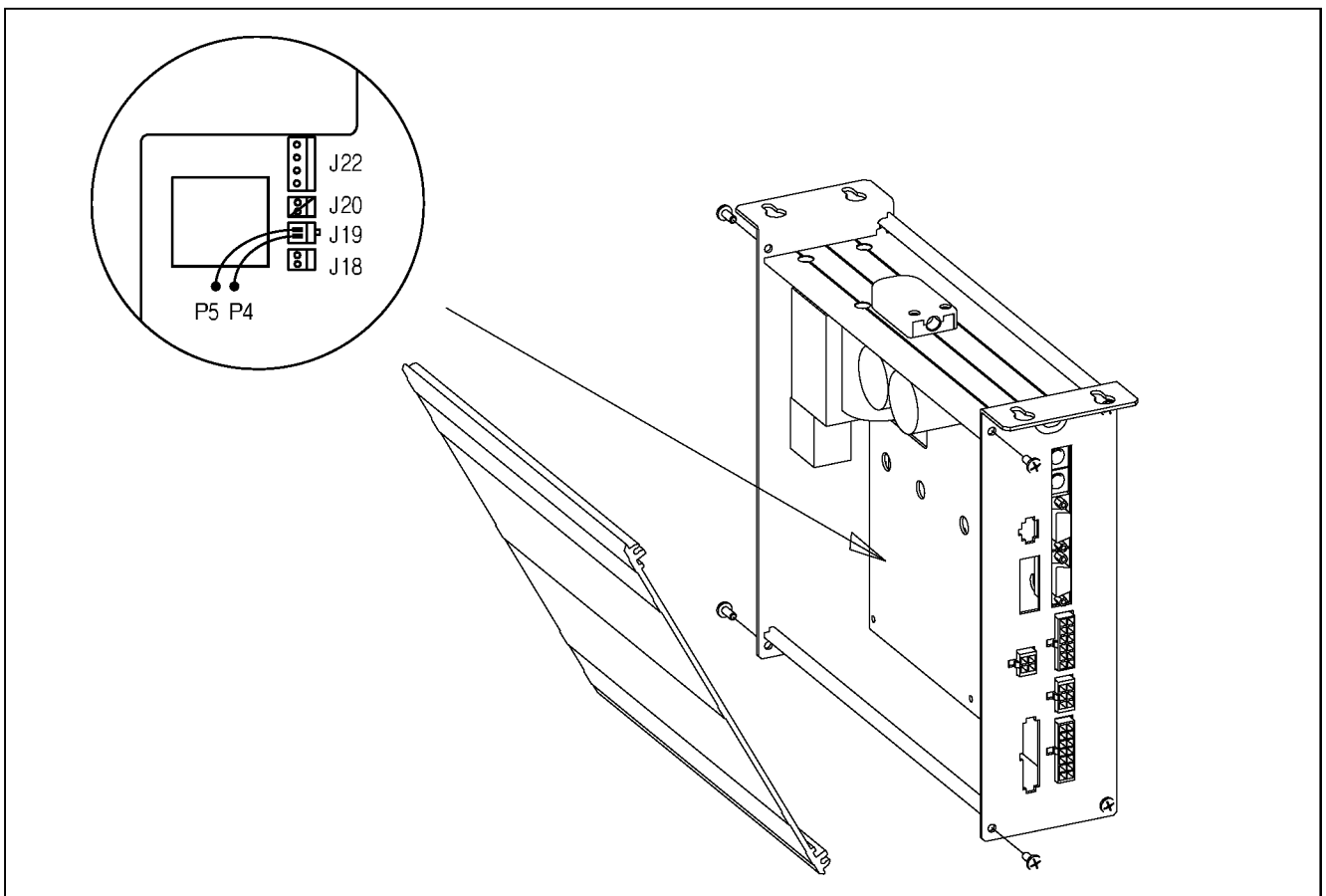

5

CONNECTION THE EARTH WIRE OF THE SEWING MACHINE AND MOTOR

► Method

As in the figure, connect grounding conductors (green or green/yellow) that link the machine and the controller. Check if grounding part of power is connected to the grounding conductors.

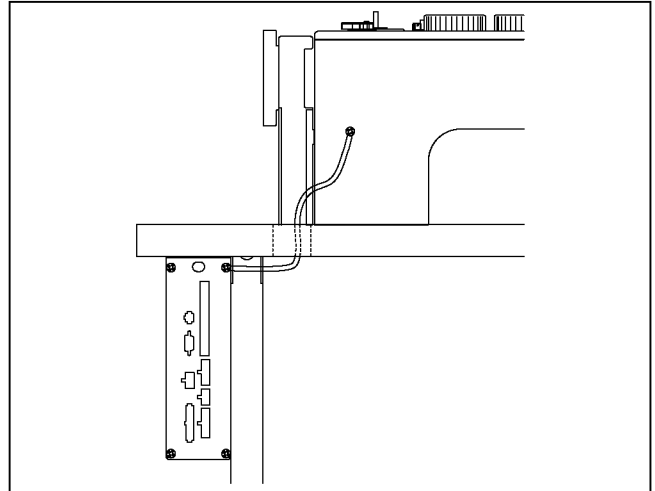
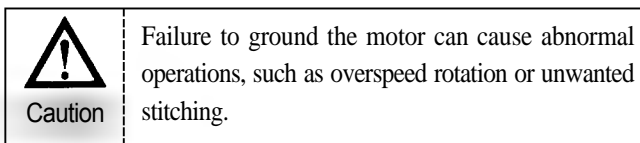

6

THINGS TO BE CHECKED AFTER INSTALLATION

1) Before the power is on...

- ① Make sure that the incoming voltage is in accordance with that shown in the name plate of the Control box.
- ② Check whether the following connectors are connected.
- ③ Check to see the fixing nuts for pulley are tightly fastened.
- ④ Check whether the sewing machines are right kinds (Chain Stitch S/M, Lock Stitch S/M)
 Check the rated voltage for Solenoid (Refer to "How to change the electric voltage supplied for Solenoid")

2) After the power is on...

- ① Check whether the program unit is working.
- ② Check the direction of rotation of the Sewing Machine.
 - In case the direction of rotation is not right, action shall be taken to change set it right, referring to "the methods of changing the program and the list of changing functions" (N. 65 in Group "A")
- ③ Check to see whether there are abnormal heat, smell or noise nearby.
 - In case there are, turn the power off and call our regional office.

PARTS NAME AND USE OF SMALL-TYPE PROGRAM OPERATING PANEL

※ Prior to sewing, the value of Group A, No. 78 shall be changed according to the operating panel type.

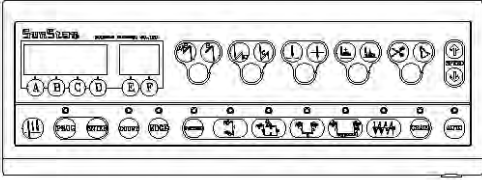
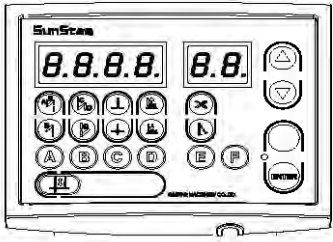
Group A, No. 78	Mode	Type of program operating panel
0	Full Function program operating panel	
1	Small-type Program Operating Panel Mode	

1) Parts Name of Small-type Program Operating Panel

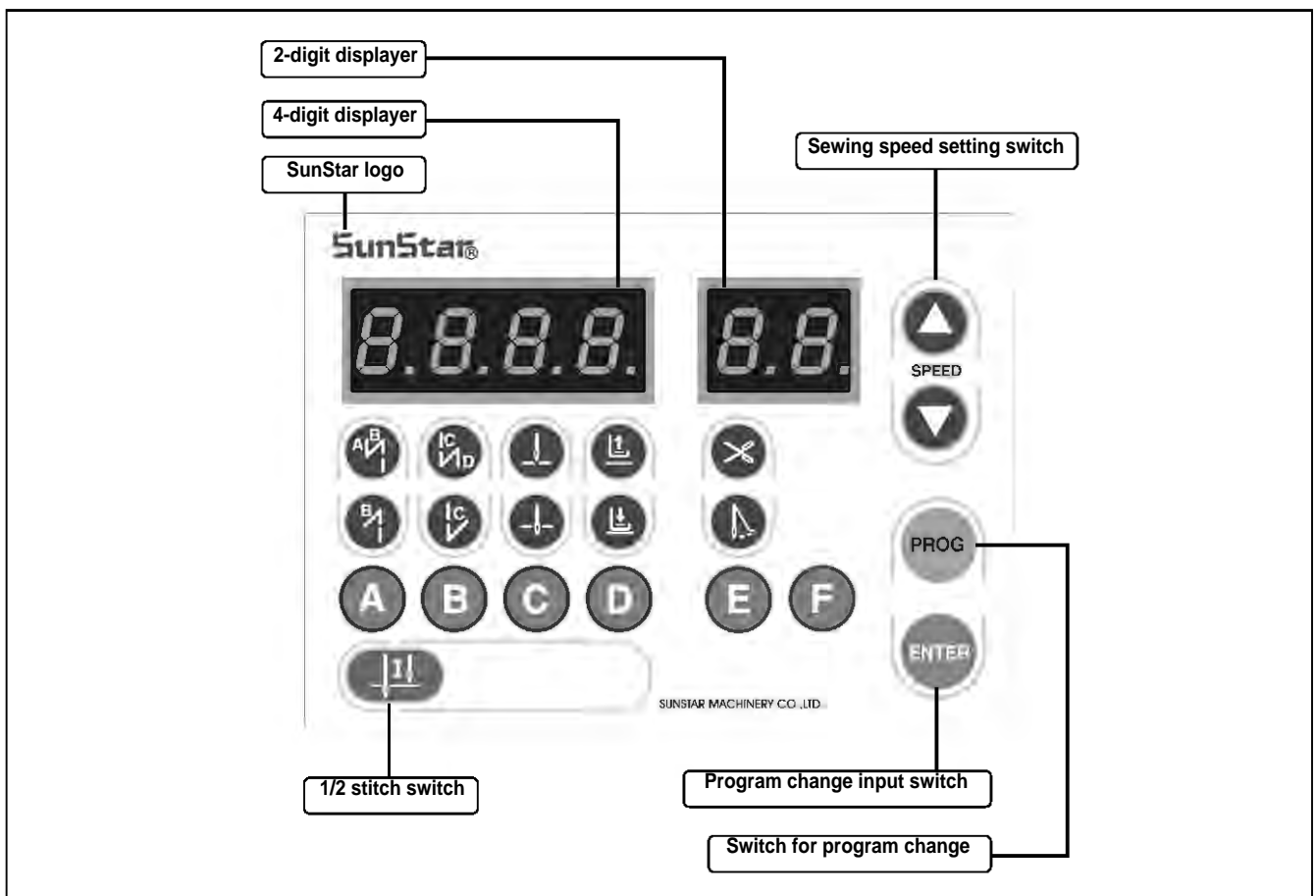

2) Use of Small-type Program Operating Panel

※ Unless specified otherwise, the usage is same to that of the full function program operating panel. Please see the usage of the full function program operating panel previously described.

(1) Initialization

- ▶ To initialize, turn on the power while the concerned buttons are being pressed.
- ▶ Follow the instructions below for initialization.

 + "Power On"
Intl-0
Initialize the current parameter value to the default value









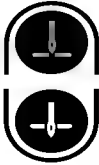

Caution

- When initialization is conducted, all user-defined values are initialized to the default values. Unless inevitable, do not use the initialization function.
- After initialization, 5-second spinning shall be conducted at the speed of 1000[rpm] or above to make the location of synchro memorized.
- The arbitrary parameter initialization by user could cause error or breakdown of the machine. User should fully understand the function before use.

(2) Needle bar upper/lower stop position setting

A. Upper stop position setting





<p>① Press  on the program unit, and the needle bar upper stop () lamp is on.</p>	
<p>② When the upper stop lamp is on, press  while PROG is being pressed. Then, as in the beside figure, the description for the current setting and the figure indicating the current position blink.</p>	
<p>③ User spins the pulley by hand in the forward direction to locate the needle bar at the desired position. Then the screen displays the changed location of the needle bar.</p>	
<p>④ If the needle bar is at the desired position, press  to save the changed position information. Then with the beep sound, the screen returns to the initial screen.</p>	

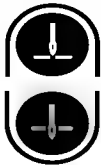

Caution

If only **PROG** is pressed on the setting screen without pressing , user would exit the screen without saving the changed value.

B. Lower stop position setting

<p>① Press C on the program unit, and the needle bar lower stop (+) lamp is on.</p>	
<p>② When the lower stop lamp is on, press ↓↑ while PROG is being pressed. Then, as in the beside figure, the description of the current setting and the figure indicating the current position blink.</p>	
<p>③ User spins the pulley by hand in the forward direction to locate the needle bar at the desired lower stop position. Then the screen displays the changed location of the needle bar.</p>	
<p>④ If the needle bar is at the desired position, press ENTER to save the changed position information. Then with the beep sound, the screen returns to the initial screen.</p>	



Caution

If only **PROG** is pressed on the setting screen without pressing **ENTER**, user would exit the screen without saving the changed value.







(3) Reverse stitch number setting

For reverse stitch setting, one of the three modes can be chosen under No. 79 of Group A.

<Scope of reverse stitch number setting >

Mode	Value of Group A , No. 79	Scope of stitch number setting	Remarks
1	0	0~9 stitches	
2	1	0~F stitches	<i>A</i> (A : 10 stitches), <i>b</i> (B : 11 stitches) <i>C</i> (C : 12 stitches), <i>d</i> (D : 13 stitches) <i>E</i> (E : 14 stitches), <i>F</i> (F : 15 stitches)
3	2	0~99 stitches	







A. Reverse Stitch Number Setting Between 0 and 9

① Set Group A, No. 79 at 0.	
② Press either one of A B C and D , while ENTER is being pressed. By pressing either one of the above buttons, it is possible to enter the reverse stitch number setting mode.	
③ The 4-digit displayer blinks.	
④ While the displayer blinks, enter the desired initial or end reverse stitch number using the A B C D buttons for setting.	
⑤ When the setting is complete, press ENTER to save.	
⑥ The 4-digit displayer does not blink any more.	



Please remember that if the initial/end reverse stitch number is set at "0," it is impossible to conduct the initial/final reserve sewing.

B. Reverse Stitch Number Setting Between 0 and F

<p>① Set Group A, No. 79 at 1.</p>	
<p>② Press either one of A B C and D, while ENTER is being pressed. By pressing either one of the above buttons, it is possible to enter the reverse stitch number setting mode.</p>	
<p>③ The 4-digit displayer blinks.</p>	
<p>④ While the displayer blinks, enter the desired initial or end reverse stitch number using the A B C D buttons for setting.</p>	
<p>⑤ When the setting is complete, press ENTER to save.</p>	
<p>⑥ The 4-digit displayer does not blink any more.</p>	



Caution

Please remember that if the initial/end reverse stitch number is set at "0," it is impossible to conduct the initial/final reserve sewing.

C. Reverse stitch number setting between 0 and 99 (If Group A, No. 79 is 2)

<p>① Set Group A, No. 79 at 2.</p>	
<p>② While ENTER is being pressed, press a desired stitch button for setting among A B C and D.</p>	
<p>③ Set the desired stitch number by pressing C (increase) or D (decrease).</p>	
<p>④ When the setting of the desired stitch number is complete, press ENTER to save. The 4-digit displayer is displayed as in the right-side figure.</p>	
<p>⑤ The 4-digit displayer does not blink any more.</p>	

<p>Caution</p>	<p>Please remember that if the initial/end reverse stitch number is set at "0," the initial/end reverse sewing is impossible.</p>
----------------	---

3) Use method of product counter and bobbin counter



Caution

Bobbin counter and the product counter are not available simultaneously due to the limitation of button at the small time PV. If two counters are enabling at the same time, they will be disabled.

Detailed method for the product counters functions

To use the counter functions, it is need for some detailed items to be set.

<p>(a) To use the product counter function, first set the value of the parameter B-35 (group B, item 35) as desired.</p> <ul style="list-style-type: none"> • 0: Set the external counter switch on • 1: Set the automatic counter on after trimming <p>※ As the default value is set "0", the counter will not run if there is no external counter switch.</p>	
<p>(b) Set the parameter B-36 to select the type of product counter</p> <ul style="list-style-type: none"> • 1: Up counter • 0: Down Counter <p>※ The default value is set at "1".</p>	
<p>(c) Press the counter F button to set the counter function. Press the button to check and set the detailed data of the counter.</p> <ul style="list-style-type: none"> • Cn: The current counter amount • rn: The remaining amount • %: The progress • tn: Total target amount (Default: 100) <p>※ Press F button repeatedly to see the above detailed data in order. The user may set up the current counter amount (Cn) and the total target amount (tn) as desired.</p>	<p><The current amount></p> <p><The remaining amount></p>
<p>(d) After the total target amount is set, use B-37 and B-38 to set the movements.</p> <p><Set value of B-37></p> <ul style="list-style-type: none"> • 0: When work is finished, the buzzer will go off and sewing may begin • 1: When work is finished, the buzzer will go off and sewing may begin only when the PROG button is pressed • 2: When work is finished, the buzzer will not go off and sewing may begin <p><Set value of B-38></p> <ul style="list-style-type: none"> • 0: No returning to automatic initial value when counting is complete • 1: Returning to automatic initial value when counting is complete 	<p><The progress></p> <p><Total target amount></p>
<p>[Caution] When B-38 is set at "0", the value will keep on going up/down even when counting is complete. The user will need to re-set the value of Cn to restart.</p>	

② How to use the detailed functions of bobbin counter

Bobbin counter is designed to check the remaining amount of the lower thread.

a. To use the counter, set detailed functions beforehand.

<p>(a) To use the bobbin counter function, first set the value of the parameter B-39 (Group B, item 39).</p> <ul style="list-style-type: none"> • 0: Bobbin counter function not used • 1: Bobbin counter function used <p>※ The default value is set at "0". At this point, the bobbin counter will not start even when the counter button in the program unit is set at bobbin counter function.</p>	
---	--

b. Detailed functions of bobbin counter

<p>(a) Select the bobbin counter function by pressing button to get the lamp flashing. Press F button and the display will change as shown in the right. "bc" stands for bobbin counter.</p>	
--	--





<p>(b) At this point, press F button to change the display to "UP". Press F button again to go back to the initial display of "3333 bt". Press F again to change to "bc" as explained in ①. The display will change by pressing F button.</p>	
---	--

<p>• [bc]</p>	<p>Bobbin counter. The value will go down from the set value during sewing. (Initial value: 0, Set range: 0~9999, How to set: use C / D button)</p>
<p>• [UP]</p>	<p>This value will go up in proportion to the reduction ratio of "bc (bobbin counter)" Use this value to get the initial value of "bc (bobbin counter)" (Initial value: 0, Set range: 0~9999, Set manual increase/decrease function with C/D button)</p>
<p>• [bt]</p>	<p>Back-tack function that is shown in the initial display</p>

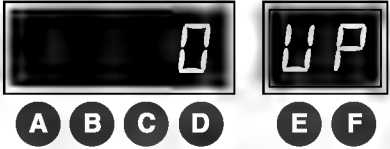

[Caution]

- ※ Pay caution when using **A** button and button, designed to perform special functions for bobbin counter.
- **A** button (Clear/Preset) : Press **A** button when "bc" is shown on the display. Then the buzzer will go off and the current value will be stored as indicated, and will change to the value of bobbin counter.
 - button (Store counter value) : Press button when "bc" or "UP" is shown on the display. The current indicated value will be stored as value of bobbin counter.

c. Setting Bobbin Counter Functions

<p>(a) When you start new sewing work, you must re-set the value of bobbin counter. Refer to the following if you do not know your re-set value.</p> <ul style="list-style-type: none"> • First move to "UP" display and use C, D button to change the value to "0". • Replace old lower thread with the new one. The amount of the lower thread must be consistent. • Begin sewing. The more you sew, the higher the value of "UP" will be. • Continue sewing until you run out of the lower thread. • When there is no lower thread left during sewing, press ENTER button to store the counted value. • Before saving, subtract some 10~20 from the value in order to reflect the counted value after the lower thread ran out. 	 
<p>(b) When the bobbin counter setting is complete, move to "bc" display. Then, you will see the value you stored on "UP" display.</p>	
<p>(c) The value of "bc (bobbin count)" decreases gradually when sewing begins after completing set-up.</p>	
<p>[Caution]</p> <p>※ Before using the bobbin counter function, move to "bc" display or initial display. If you start working from "UP" display, the value of counter will go up.</p>	

d. When bobbin counter is complete

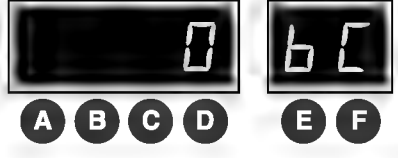
<p>(a) Replace old lower thread with the new one. Start sewing and the value of "bc (Bobbin counter)" will go down gradually.</p> <p>(b) Take note that the buzzer will go off when the value goes down below 20. This is to warn that there is little lower thread left.</p>	 
<p>(c) Continue sewing till the value of bobbin counter hits "0." Then sewing will stop, buzzer will go off, and the display will start to flash.</p>	
<p>(d) When sewing stops after counting is complete, use the following method to return.</p> <ul style="list-style-type: none"> • Press ENTER to change to the automatically stored value of "bc." (AUTO CLEAR/PRESET) 	
<p>[Caution]</p> <ul style="list-style-type: none"> ※ To use the bobbin counter function, first set B-Group 39 to "1." ※ Use F button to change the display to set/clear the value of bobbin counter during sewing. ※ A button is used to set the value of bobbin counter on "bc" display or to return to the default value. Press A button to clear the current value and recall the stored counter value. ※ Wind the lower thread with consistency to ensure the proper use of bobbin counter functions. Counter functions may work differently depending on lower thread and sewing conditions. 	

4) Using Method of the Short Thread Trimmer Type

 Caution	Short Thread Trimmer type is applicable after Ver.06 of Fortuna-4 750[W].
---	---

(1) Short thread trimmer model number and related type

No.5, Group B	Related type
No.115	KM-1070BLX-7 (option type)

(2) Extension port specification of the short thread trimmer(option 3; 5566-20P)

In case of short thread trimmer type, FET board (option) for extension port inside of the control box is added. Therefore check the type name of short thread trimmer.

Type	Type name
KM-1070BLX-7 (option type);220[V]	S4AC75-2A-115
KM-1070BLX-7 (option type);110[V]	S4AC75-1A-115

② Extension port connector pin of short thread trimmer type formation and coupling

A. Connector pin formation

[Pin Number]									
20	19	18	17	16	15	14	13	12	11
10	9	8	7	6	5	4	3	2	1
1, 2, 7~10 : GND					13 : EXI00				
3~6 : +48[V]					14 : Output 15				
11 : Output 12					15 : Output 14				
12 : Output 13					17, 18 : +5[V]				
					19, 20 : +12[V]				

B. Connector coupling

Link the air-compressed signal cable to no.5 and no.15 each.

 Caution	<ol style="list-style-type: none"> 1. Check the type name of the control box by all means. 2. Link the air-compressed signal cable properly.
---	--

(3) Using method of parameter related short thread trimmer

When the model number of B-56 is set to "115", the following thread trimming sequence is saved automatically to the B-55.

Flow chart	Program code					
	No.	Instructions	1st	2nd	3rd	Description
	01	--80				Start thread trimming sequence
	02	--8F				Short thread trimmer solenoid ON
	03	--CF				Stitching as much as x stitches at the 600RPM
	04		600			
	05			0		
	06	--F3				Thread trimming sequence
	07	--A6				Short thread trimmer solenoid OFF
	08	--00				Finish Thread trimming sequence
	:	--00				
	64	--00				Finish thread trimming sequence

※ The shadowed parts indicate that the user can set the short thread trimming speed and stitch length.

② When users want to manipulate the short thread trimming speed and stitch length, set as follows.

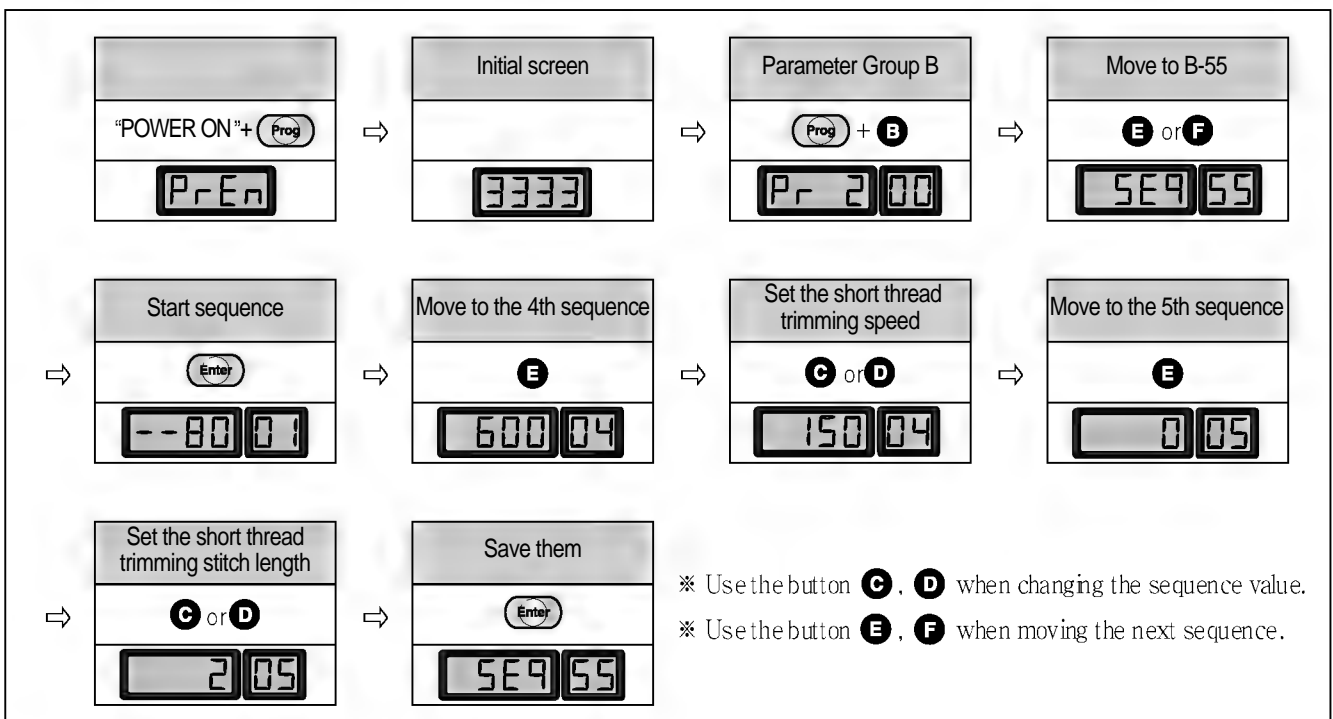

The last one stitch before trimming the short thread trimmer type is operated as short thread trimmer.

5) Initial and Close Backtack Accuracy Function Correction Method



Caution

1. Before the backtack correction, check the gap between forward and backward feed. If there is the gap, the proper backtack correction is not available.
2. When the solenoid type is air-compressed, backtack solenoid is affected depending on the strength. If the backtack is not corrected with only the backtack correction function, manipulate the strength of the air pressure.

(1) Setting parameter (the initial value can be different by the applicable M/C type)

No.	Function	Function Initial value(ms)	Range	Phase[ms]
No.85, Group B	Initial backtack solenoid ON maintenance time	4	4 ~ 1020[ms]	4
No.86, Group B	Initial backtack solenoid OFF maintenance time	4	4 ~ 1020[ms]	4
No.87, Group B	Close backtack solenoid ON maintenance time	4	4 ~ 1020[ms]	4
No.88, Group B	Close backtack solenoid OFF maintenance time	100	4 ~ 1020[ms]	4

(2) Correction method

<p>① When the first backtack stitch length of line B is short</p> <p>☞ Increase the initial backtack solenoid ON maintenance time (no.85, Group B)</p>	
<p>② When the first backtack stitch length of line B is long</p> <p>☞ Decrease the initial backtack solenoid ON maintenance time (no.85, Group B)</p>	
<p>③ After initial backtack, the first stitch length is short</p> <p>☞ Increase the initial backtack solenoid OFF maintenance time (no.86, Group B)</p>	
<p>④ After initial backwards, the first stitch length is long</p> <p>☞ Decrease the initial backtack solenoid OFF maintenance time (no.86, Group B)</p>	
<p>⑤ When the first backtack stitch length of line C is short</p> <p>☞ Increase the close backtack solenoid ON maintenance time (no.87, Group B)</p>	
<p>⑥ When the first backwards stitch length of line C is long</p> <p>☞ Decrease the close backtack solenoid ON maintenance time (no.87, Group B)</p>	
<p>⑦ When the first backtack stitch length of line D is short</p> <p>☞ Increase the initial backtack solenoid OFF maintenance time (no.88, Group B)</p>	
<p>⑧ When the first backtack stitch length of line D is long</p> <p>☞ Decrease the initial backtack solenoid OFF maintenance time (no.88, Group B)</p>	

6) Small-type Program Operating Panel Functions Same as Full Function Program Operating Panel

※ Please refer to the table below showing “8. Part name and usage of full function program operating panel”.

No.	Description	Refer	Remarks
1	Function of 4-digit and 2-digit displayers	(1).A of 8-2)	
2	Confirmation or change of detailed parameter value	(1).B.b of 8-2)	
3	Function and usage of the 1/2 stitch button	(2) of 8-2)	This function cannot be used in the machine types offering function switch.
4	Usage of the initial reverse button	(3) of 8-2)	
5	Usage of the end reverse button	(4) of 8-2)	
6	Usage of the needle bar position setting button when the sewing machine stops	(5) of 8-2)	
7	Usage of the presser foot stop position setting button when the sewing machine stops	(6) of 8-2)	
8	Usage of the automatic trimming and wiper buttons	(7) of 8-2)	

FORTUNA SERIES 4 750[W] FULL FUNCTION SOFTWARE METHOD OF USE

1) Basic Functions of the Fortuna Series 4 750[W] Full Function Software

(1) Initializing

This function is used when the user randomly changes the parameter's programmed value, and forgets the original program contents.

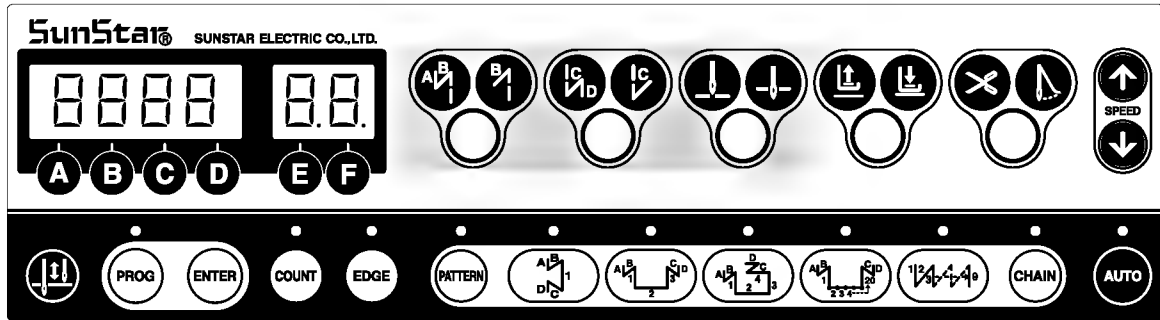

Method of initializing: Turn the power on by simultaneously pressing the buttons in the figure above which are the start B/T button + end B/T button + needle plate up/down stop button.

[Caution]

- If you initialize, all the changes made by the user are changed to the original values programmed when the machine was delivered from the factory, therefore only change the value if absolutely necessary.
- After initializing, rotate the machine for 1000RPM or more for approximately 5 seconds. You must make the machine remember the location of the FILM.

(2) Sewing Machine Up/Down Stop Location Automatic Recalling Function

When first purchasing the controller, if the user steps on the pedal for 5 seconds and runs the motor before beginning the sewing work, the machine will automatically remember the sewing machine's up/down stop location. However, when using a synchronizer this step is not necessary.

(3) Method of Use and Functions of the Program Unit and the General Control Box's Simple Operation Box.

When there is a program unit(P/U), use it to program or change all the functions of the machine. When there is no program unit, use the general control box operation panel to program or change all the functions of the machine.

※ For detailed information on the method of use of program units and simple operation panel refer to the explanation in the last section.



(4) Function Parameter

Parameter group	Functions
① Group A	General functions of the sewing machine
② Group B	All types of output, Full-on Time/PWM Duty, checking input/output operations, sewing machine models and thread trimming sequence programming
③ Group C	Pedal acceleration/deceleration curve, slow starting speed and input/output port change related parameters
④ Group D	All types of gain parameter related motor control
⑤ Group F	TPM(Total Production Maintenance)-related Parameters

※ If the specific items of the parameter are changed carelessly, they could cause breakdown or damage the machine. Therefore the user must be well-trained before using it.

2) Fortuna Series 4 750[W] Full Function Software Specific Parameters

(1) Group A Parameter: General functions of sewing machine

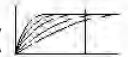
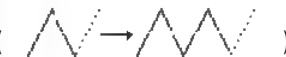
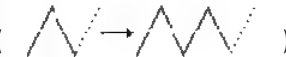
No.	Function	Initial value	Range	Step
1	Minimum speed of pedal (limit of sewing machine's minimum speed)	200spm	20-510	2spm
2	Maximum speed of pedal (limit of sewing machine's maximum speed)	4000spm	40-9960	40spm
3	Thread trimmer speed (Sewing machine speed from beginning to end of thread trimming when using CAM type)	300spm	20-510	2spm
4	Program Unit + 1 stitch speed ( Key's performance speed)	100spm	20-510	2spm
5	Lifting of needle plate with button A, dropping speed ( 's performance speed)	300spm	20-510	2spm
6	Pedal degree of acceleration (Pedal Curve) ( ;When the maximum speed is put in 255 steps)	255	1-255	1
7	Start Back-Tack Speed	1700spm	20-2000	10spm
8	End Back-Tack Speed	1700spm	20-2000	10spm
9	Thread trimming operation time (The A24 used in PNEUMATIC = must be 1) (The Solenoid operation time)	100ms	4-1020	(When doing an aging test, the value is equal to the running time)
10	Tension release operation time (The A24 used in PNEUMATIC = must be 1)	200ms	4-1020	(When doing an aging test, the value is equal to the thread trimming time)
11	Tension release time (In CAM type, the used A24 = must be 0) (In CAM type, the tension release is the value of the moving CAM angle)	255	0-255	
12	Waiting time for the next operation after thread trimming (This is the delaying time to carry out the next operation after thread trimming is finished)	4ms	4-1020	
13	Wiper operation time (Wiper Solenoid operating time)	48ms	4-1020	4ms
14	Waiting time after wiper operation (presser foot-lift etc.)	40ms	4-1020	4ms
15	Automatic presser foot-lift delaying time	100ms	4-1020	4ms
16	Automatic presser foot-lift maintaining time (After programmed time the presser foot-lift is automatically released) Automatic presser foot-lift drop waiting time for next operation	300 × 0.1sec	5-1000	0.5sec
17	(The delaying time, or the time that the foot-presser lift is maintained, the pedal is started until the presser foot-lift drops and the sewing machine is started)	100ms	4-1020	4ms
18	Selection for automatic foot-presser lift after thread trimming	0	0/1	1=lift selection 0=2step backward thread trimming
19	Selection for pedal thread trimming position	0	0/1/2	1=1 step backward thread trimming 2=thread trimming at neutral position
20	The maximum sewing speed for the KM-1060BL-7 presser foot-lift with mutual crossing quantity of 4.8-7.0[mm]	2000spm	200-2000	10spm
21	Delaying time for complete release of KM-1060BL-7 B/T Solenoid	200ms	4-1020ms	4ms
22	Select to operate 2 start B/T ()	0	0/1	Choose between 1 or 2
23	Select to operate 2 end B/T ()	0	0/1	Choose between 1 or 2
24	Selection of thread trimming conditions (selection according to sewing machine type)	0	0/1/2	0=CAM type machine 1= thread trimming after up-stop 2=thread trimming after low-stop
25	Whether or not to use default sequence when A24 = 1 (This is a sequence determined on A9,A10 value)	0	0/1	0=B-55 exclusive sequence is used 1= default sequence is used
26	Selection of B/T Solenoid operation position	0	0/1	0= lower position 1= upper position



If the specific items of the parameter are changed carelessly, they could break down or damage the machine, so the user must be well-trained before using it.

No.	Function	Initial value	Range	Step
27	Setting the maximum sewing speed of the machine according to presser foot-lift height of the KM-1060BL sewing machine.	?	?	Less than P1xx:3500[spm] Less than P2xx:3000[spm] Less than P3xx:2500[spm] More than P3xx: A20[spm] program P1xx → P2xx → P3xx in order
28	Needle bar's automatic stop at the highest position	0	0/1	1
29	Pedal analog filtering difference	10	1~30	1=selection of semi-automatic
30	When using an angle 2-needle, select the semi-automatic corner operation	0	0/1	10spm
31	Speed when selecting a semi-automatic corner (parameter used only when used after selecting number 30)	200spm	20~2000	10spm
32	After selecting the left needle the first sewing stitch (parameter used only when used after selecting number 30)	3 stitches	0~255	1 stitch
33	After selecting the left needle the second sewing stitch (parameter used only when used after selecting number 30)	3 stitches	0~255	1 stitch
34	After selecting the right needle the first sewing stitch (parameter used only when used after selecting number 30)	3 stitches	0~255	1 stitch
35	After selecting the right needle the second sewing stitch (parameter used only when used after selecting number 30)	3 stitches	0~255	1 stitch
36	Maintaining time for the left/right needle solenoid (After the programmed time the solenoid is automatically released)	450 × 0.1sec	(50~1000)	0.5sec
37	Set grease check function	0	0/1	0 : Not used 1 : Used
38	Set grease check time	750 (hour)	0~9999	1 (hour)
39	Stopping function during AUTO mode and while pedal is neutral	1	0/1	0=does not stop 1=stops
40	Selection of type of N-stitch Sensor	0	0 : active high	1 : active low
41	The number of stitches done after the N-stitch Sensor has finished sensing. (After sensing, it will sew the programmed number of stitches and stop)	3 stitches	0~255	1 stitch
42	N-stitch sewing speed	1000spm	20~2000	10spm
43	Selection of One Touch function (Used in the sewing mode that uses the auto function)	0	0/1	1=Auto Mode
44	Selection of One Touch function (If there is no thread trimming signal when selected, sewing will continue even if user releases pedal)	0	0/1	1=One-Shot Mode
45	One-Shot sewing speed	2000spm	40~9960	40spm
46	N-stitch sewing mode selection → a sewing mode that inputs a sensor signal in the edge sensor port and uses it as an edge sensor	0	0/1	1=N-stitch Mode
47	Selection of pre-stitch function (When selected it will perform only the programmed stitches before the actual sewing work starts)	0	0/1	1=selection
48	Pre-stitch number of stitches	3 stitches	0~255	1 stitch
49	Pre-stitch speed	2000spm	20~2000	10spm
50	Selection of start B/T operating conditions (0 : if pedal is released during back tack, it will stop) (1 : if pedal is released during back tack, the work will still be completed) (2 : it will perform the exact amount of back tack stitches)	1	0 : B/T stop function selected 1 : B/T work completion 2 : B/T exact stitch performance	
51	Selection of end back tack performance condition (It will perform the exact amount of stitches for end back tack)	0	0/1	1= exact stitch performance
52	Back tack initial first stitch speed during back tack exact performance	200spm	20~1000	10spm
53	Change between B/T and switch with buttons A or B during sewing	0	0/1	1= Select with button B
54	Selection of button A function	2	0 : Only B/T operates 1 : Lift and drop needle plate with one movement. 2 : Lift needle plate with one movement. Drop needle plate with two movements 3 : Slow performance when stopped (1/2 stitch speed)	



Caution

If the specific items of the parameter are changed carelessly, they could break down or damage the machine, so the user must be well-trained before using it.

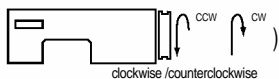
No.	Function	Initial value	Range	Step
55	Selection of Button B function	0	0 : B/T delete insertion 1 : Lift and drop needle plate with one movement 2 : Slow performance when stopped (1/2 stitch speed) 3 : Only B/T operates	
56	Selection of speed during manual back tack during sewing	0	0/1	0 : current sewing speed 1: initial reverse speed
57	NOT USED			
58	Thread Trimming Sequence Selection of SunStar Chain Stitch Machine	1	0/1	1
59	Thread Trimming Sequence Selection of other Company chain Stitch Machine	0	0/1	1
60	Selection of reverse rotation after trimming	0	0/1	1:selection of reverse direction
61	Reverse rotation distance when selecting reverse rotation after thread trimming	30degree	0~250	1degree
62	When machine stops fix pulley (When machine stops fix the motor by force)	0	0/1	1: fix when machine stops
63	Power to fix the A number 62 Pulley	40	10~100	1
64	Distance recovered after fixing A number 62 Pulley and rotating it by force	20degree	10~100	1degree
65	Select the motor rotating direction ()	1	0/1	1 : clockwise 0 : counterclockwise
66	Target speed : If this speed is reached or passed, a signal saying "Target speed has been reached" will appear.	1000spm	40~9960	40spm
67	Delay start setup	0	0/1	0=normal start 1=Delay start
68	Delay start time duration setup	3	3~250	1 ×100[ms]
69	Setup of needle bar's stop at the lowest position after trimming when the pedal is pressed	0	0/1	0=disabled 1=enabled
70	Setup of the duration of needle bar's stop at the lowest position after trimming when the pedal is pressed	100	100~250	1[ms]
71	Fixing of edge sensor	0	0/1	0=disabled 1=enabled
72	Detection time of high-voltage error	10	2 ~1020[ms]	2 [ms]
73	Use of the upper trimming device	0	0/1	0=disabled 1=enabled
74	Hammering function	0	0/1	0=disabled 1=enabled
75~76	NOT USED			
77	Speed limit by stitch length	Depends on models	40~9960[spm]	40[spm]
78	Program unit select	1	0/1	0 : Full Function Type 1 : Small Type
79	Expand stitch count set with backtack	0	0/1/2	0 : 0~9stitches 1 : 0 ~ F(15)stitches 2 : 0 ~ 99stitches
80	Stitch length reduction upon backtack execution (Can be used only when the stitch length conversion device is enabled)	0	0/1	0 : Unused 1 : Used
81	Prevent automatic presser foot lift (Must use this function for the models equipped with air solenoid only)	0	0/1	0 : Unused 1 : Used
82	Not Used	-	-	-
83	Not Used	-	-	-

 Caution	<p>If the specific items of the parameter are changed carelessly, they could break down or damage the machine, so the user must be well-trained before using it.</p>
---	--

No.	Function	Initial value	Range	Step
84	Thread release solenoid motion mode (Setting the thread release solenoid motion status when the presser foot is lifted up)	0	0 : Power On and presser foot up after trimming → The thread release solenoid is not open. 1 : Presser foot up → The thread release solenoid is open.	
85	Sewing speed display function	0	0/1	0 : Unused 1 : Used
86	Initialize various solenoids after trimming	0	0 : Each solenoid and LED OFF after trimming 1 : Each solenoid and LED ON after trimming	
87	Setting the seam center action mode		0 : manual mode • seam center switch ON(OFF) → seam center ON(OFF) 1 : semi-automatic / automatic mode • seam center action in case of semi-automatic mode (starting stitching during the seam center switch is ON) ☞ seam center switch ON(seam center ON) → initial BT(seam center OFF) → stitching(seam center ON) → finish BT(seam center OFF) → thread trimming and stitching finish(seam center OFF) • seam center action in case of automatic mode (starting stitching during the seam center switch is OFF) ☞ seam center switch OFF(seam center OFF) → initial BT(seam center OFF) → stitching(seam center ON after stitching A-89) → finish BT(seam center OFF) → thread trimming and stitching finish(seam center OFF)	
88	Automatic seam center setting stitch length (the stitch length the seam center is ON when A-88 is 1)	1stitch	0-255	1stitch
89	Not Used			
90	While the sub-thread release device button is on, turn off and on power, and select the sub-thread release solenoid in use (can be used after changing A-95 to 1)	0	0 : While the sub-thread release device button is on, turn off and on power, and cancel the sub-thread release device. 1 : While the sub-thread release device button is on, turn off and on power, and continue to use the sub-thread release device.	
91	Select a sub-thread release (Climb Device) solenoid control mode	0	0 : In the event of switch on/off, turn on/off LED only. 1 : In the event of switch on/off, turn on/off the solenoid and Led together.	
92	Initialize stitch length conversion after trimming	0	0 : Unused 1 : Solenoid ON even after trimmin	
93	Initialize height adjustable presser foot (Climb Device) after trimming	0	0 : Not used 1 : Solenoid ON even after trimming	
94	Initialize seam center guide after trimming	0	0 : Unused 1 : Solenoid ON even after trimmin	
95	Initialize the sub-thread release (Dual Tension) solenoid after trimming	0	0 : Not used 1 : Solenoid ON even after trimmin	
96	Select top/bottom speed during height adjustable presser foot motion (Max. speed for each step is higher when "1" is selected instead of "0")	1	0/1	0 : Climb low speed 1 : Climb high speed
97	Select the independent left/right control of the sub-thread release device (Model No : applicable in the event of 106/112)	0	0 : When Left or Right switch is pressed, left/right LED and SOL are put into motion simultaneously. 1 : When left or right switch is pressed, [left LED and left Sol] / [right LED and right Sol] are separately in motion.	
98	Set the automatic motion of the sub-thread release	0	0 : Not used 1 : While the height adjustable presser foot is in motion, the sub-thread release solenoid is automatically turned on.	
99	Enable/disable speed limit by the height adjustable presser foot	0	0 : Enable speed limit by the height adjustable presser foot 1 : Disable speed limit by the height adjustable presser foot	



If the specific items of the parameter are changed carelessly, they could break down or damage the machine, so the user must be well-trained before using it.

(2) Group B Parameter : All types of output, Full-on Time/PWM Duty, checking input/output operations, sewing machine models and thread trimming sequence programming.

※ These are functions not used by general users and must be regulated by an A/S technician.

No.	Function	Initial value	Range	Step
1	Back Tack Solenoid Initial Full On Time	1020ms	4~1020	4ms
2	Presser Foot-Lift Solenoid Initial Full On Time	200ms	4~1020	4ms
3	T/T Solenoid Initial Full On Time	100ms	4~1020	4ms
4	Wiper Solenoid Initial Full On Time	100ms	4~1020	4ms
5	Tension Release Solenoid Initial Full On Time	100ms	4~1020	4ms
6	Left Solenoid Initial Full On Time (For Twin Needle)	100ms	4~1020	4ms
7	Right Solenoid Initial Full On Time (For Twin Needle)	100ms	4~1020	4ms
8	Auxiliary Solenoid Initial Full On Time	100ms	4~1020	4ms
9	Left LED Initial Full On Time (For Twin Needle)	100ms	4~1020	4ms
10	Right LED Initial Full On Time (For Twin Needle)	100ms	4~1020	4ms
11	Needle plate up-stop signal Initial Full On Time	100ms	4~1020	4ms
12	Needle plate down-stop signal Initial Full On Time	100ms	4~1020	4ms
13	Signal notifying motor running Full On Time	100ms	4~1020	4ms
14	Signal notifying target speed achieved Full On Time	100ms	4~1020	4ms
15	Back Tack Solenoid Duty Ratio	50%	0~100	10%
16	Presser Foot-Lift Solenoid Duty Ratio	20%	0~100	10
17	Thread Trimming Solenoid Duty Ratio	100	0~100	10
18	Wiper Solenoid Duty Ratio	100	0~100	10
19	Tension Release Solenoid Duty Ratio	100	0~100	10
20	Left Solenoid Duty Ratio (For Twin Needle)	50	0~100	10
21	Right Solenoid Duty Ratio (For Twin Needle)	50	0~100	10
22	Aux Solenoid Duty Ratio	100	0~100	10
23	Left LED Duty Ratio (For Twin Needle)	100	0~100	10
24	Right LED Duty Ratio (For Twin Needle)	100	0~100	10
25	Signal for up stopping needle Duty Ratio	100	0~100	10
26	Signal for low stopping needle Duty Ratio	100	0~100	10
27	Signal notifying motor running Duty Ratio	100	0~100	10
28	Signal notifying target speed reached Duty Ratio	100	0~100	10
29	NOT USED			
30	Start Back Tack A number of stitches correction value	00.30	6~6	0.05 Stitch
31	Start Back Tack B number of stitches correction value	00.30	6~6	0.05 Stitch
32	End Back Tack C stitch correction value	00.40	6~6	0.05 Stitch
33	End Back Tack D stitch correction value	00.40	6~6	0.05 Stitch
34	Selection for maintaining reverse solenoid movement when thread trimming (C Only B/T)	0	0/1	1=reverse direction maintained
35	Programming count condition (program whether or not automatic counter will be operated)	0	0/1	0=counter used 1=automatic counter after thread trimming
36	When automatically counting, select Up/Down count after thread trimming (thread trimming function must be enabled)	1	0/1	1=Up COUNT 0=DOWN COUNT
37	When count in completed, the next operation is programmed	0	0/1/2	0=buzzer rings, sewing is allowed 1=buzzer rings, sewing is not allowed (If you press the Prog Key, set up is cancelled) 2=No buzzer ring, sewing is allowed
38	When count is completed, select the counter auto clear/preset	0	0/1	1=AUTO CLEAR/PRESET
39	Bobbin counter set-up	0	0/1	0=Bobbin counter Disable 1=Bobbin counter Enable

※ Items No. 30~33 : These are the items that make the number of stitches match when back tack number of stitches do not match.

※ Solenoid Duty Ratio : The power that holds and maintains the solenoid.

Solenoid initial full on time : The time it takes to pull the solenoid to the maximum in the outset.

[Caution]

If the specific items of the parameter are changed carelessly, they could break down or damage the machine, so the user must be well-trained before using it.

No.	Function	Initial value	Range	Step
40	Checks operation of B/T solenoid (OUTPUT00)	※ After matching the number of the solenoid being tested, press the "1stitch()" key and check the condition of the movement. - Along with the output, it will say "on", or "off"		
41	Checks operation of P/F solenoid (OUTPUT01)			
42	Checks operation of T/T solenoid (OUTPUT02)			
43	Checks operation of W/P solenoid (OUTPUT03)			
44	Checks operation of T/R solenoid (OUTPUT04)			
45	Checks operation of left solenoid (OUTPUT05)			
46	Checks operation of right solenoid (OUTPUT06)			
47	Checks operation of Aux. solenoid (OUTPUT07)			
48	Checks operation of Left LED solenoid (OUTPUT10)			
49	Checks operation of Right LED solenoid (OUTPUT11)			
50	Checks operation of needle when signal notifies up stop (OUTPUT12)			
51	Checks operation of needle when signal notifies down stop (OUTPUT13)			
52	Checks operation of signal notifying motor running (OUTPUT14)			
53	Checks operation signal notifying target speed has been reached (OUTPUT15)			
54	Select [Thread trimming sequence] - The default is set to '0'. If you wish to input another sequence apart from the thread trimming sequence provided in the system input the newly composed sequence number. (Refer to the sequence composition method)	0	0~64	1
55	Thread trimming sequence data writing function			
56	Selecting sewing machine model - write the number that fits the sewing machine model provided in the full function manual.. - thread trimming sequence in the pertinent machine is copied. - if you want to correct the thread trimming sequence, change the contents of item B-55. (※ However, be aware that if you initialize the parameter, the newly programmed changes will disappear and the thread trimming sequence will change to that of [SunStar 235/250]).	0	0~127	1 0~ 74 (non-order made) 75~118 (order-made) (Refer to attached material)
57	Independent operation of trimming sequence	0	0/1	0=operation after trimming 1=independent operation
58	Presser foot-lift solenoid slowing down time #1 (Applied only when it is full-on condition)	40ms	2~510ms	2ms
59	Presser foot-lift solenoid slowing down time #2 (Applied only when it is PWM)	30ms	2~510ms	2ms

※ Items No. 40~53 : functions that check if solenoid and other output signals are working properly.

※ Select Item No. 55 and press the Enter key. Along with the buzzer sound you will see the words "Seq 55" appear on the screen. Thread trimming sequence composition permitting condition is now possible. You can program a thread trimming sequence to a maximum of 64 bytes. (For thread trimming sequence program method, refer to attached material).

[Caution]

If the specific items of the parameter are changed carelessly, they could break down or damage the machine, so the user must be well-trained before using it.

No.	Function	Initial value	Range	Step
60	Checks the signal input INPUT00 (Button A)			
61	Checks the signal input INPUT01 (Button B)			
62	Checks the signal input INPUT02 (1/4 stitch Switch)			
63	Checks the signal input INPUT03 (2/4 stitch Switch)			
64	Checks the signal input INPUT04 (3/4 stitch Switch)			
65	Checks the signal input INPUT05 (4/4 stitch Switch)			
66	Checks the signal input INPUT06 (Left Switch)			
67	Checks the signal input INPUT07 (Right Switch)			
68	Checks the signal input INPUT10 (Manual presser foot-lift Switch)			
69	Checks the signal input INPUT11 (Counter Switch)			
70	Checks the signal input INPUT12 (PU 1/2 stitch Button)			
71	Checks the signal input INPUT13 (Safety Switch)			
72	Checks the signal input INPUT14 (Edge Sensor)			
73	Checks the signal input INPUT15 (Thread trimming not allowed)			
74	Checks the signal input INPUT20 (First step for pedal going forward)			
75	Checks the signal input INPUT21 (First step for pedal going backwards)			
76	Checks the signal input INPUT22 (Second step for pedal going backwards)			
77	Checks the solenoid movement voltage		0~64	
78	Checks external volume value		0~64	
79	Checks the pedal analog output		0~64	
80	Checks the synchronizer signal			Increases by each rotation of the sewing machine
81	Checks the signal from encoder A/B			1) Increases when sewing machine rotates clockwise rotates clockwise 2) decreases when sewing machine rotates in counterclockwise
82	Checks the signal from encoder R/S/T			1) When sewing machine is rotating clockwise 101 100 110 010 011 001 101 2) When sewing machine is rotating counterclockwise 101 001 011 010 110 100 101
83~84	NOT USED			
85	Start backtrack On maintain time	4[ms]	4~1020[ms]	Parameters in motion when the backtrack accuracy function is used.
86	Start backtrack OFF maintain time	4[ms]	4~1020[ms]	
87	End backtrack ON maintain time	4[ms]	4~1020[ms]	
88	End backtrack OFF maintain time	100[ms]	4~1020[ms]	
89	NOT USED			

Along with the input, it will say "on" or "off"

- * Items No. 60~76: functions that check individual normal movement.
- * Items No. 77~79 : functions that check each analog input normal movement.
- * Item No. 80 : function that checks whether the synchronizer signal is working properly.
- * Item No. 81 : function that checks whether the encoder A/B is working properly.
- * Item No. 82 : function that checks whether the encoder R/S/T is working properly.

[Caution]

If the specific items of the parameter are changed carelessly, they could break down or damage the machine, so the user must be well-trained before using it.

No.	Function	Initial value	Range	Step
90	Sewing machine pulley size	?	0~9999	1pulse
91	Distance between up-stop ~ low-stop (the standard is the pulley's normal direction rotation)	?	0~9999	1pulse
92	Programming the upper stop location (the standard is the pulley's normal direction rotation) - Not valid for model S-III	?	0~359	1degree
93	Programming the low-stop location (the standard is the pulley's normal direction rotation) - Not valid for model S-III	?	0~359	1degree
94	Index pulse occurring position (the standard is the pulley's normal direction rotation) - Turn the pulley manually and stop it in the position you want.	?	0~359	1degree
95	CAM type thread release solenoid operation position - Turn the pulley manually and stop it in the position you want.	?	0~359	1degree
96	CAM type thread release solenoid release position - Turn the pulley manually and stop it in the position you want.	?	0~359	1degree
97	CAM type thread trimming solenoid operation position - Turn the pulley manually and stop it in the position you want.	?	0~359	1degree
98	CAM type thread trimming solenoid release position - Turn the pulley manually and stop it in the position the user wants	?	0~359	1degree
99	Manual and automatic set up of solenoid operation / release position in CAM type thread trimming	1	0/1	0=manual set up 1=automatic set up

[Caution]

If the specific items of the parameter are changed carelessly, they could break down or damage the machine, so the user must be well-trained before using it.

(3) Group C Parameter: Pedal acceleration/deceleration curve, slow starting speed and input/output port change related parameter

※ These are functions not used by general users and must be regulated by an after-sales service engineer.

No.	Function	Initial value	Range	Step
1	1 step section where pedal moves forward	17	0~64	1
2	2 step section where pedal moves forward	22	0~64	1
3	3 step section where pedal moves forward	38	0~64	1
4	4 step section where pedal moves forward	47	0~64	1
5	5 step section where pedal moves forward	59	0~64	1
6	Sewing speed value in the 1 step where pedal moves forward	440spm	40~9960	40spm
7	Sewing speed value in the 2 step where pedal moves forward	920spm	40~9960	40spm
8	Sewing speed value in the 3 step where pedal moves forward	4000spm	40~9960	40spm
9	Sewing speed value in the 4 step where pedal moves forward	5480spm	40~9960	40spm
10	Sewing speed value in the 5 step where pedal moves forward	9960spm	40~9960	40spm
11	Select slow start after thread trimming (After performing thread trimming, start the next sewing work slowly)	0	0/1	1=selection
12	Select slow start after sewing machine stops (After performing sewing machine stops, start the next sewing work slowly)	0	0/1	1=selection
13	When starting slowly, select sewing speed change	0	0/1	1=Use C14~C18 value 0=Use default value
14	The speed of the first stitch when starting slow	400spm	40~9960	40spm
15	The speed of the second stitch when starting slow	400spm	40~9960	40spm
16	The speed of the third stitch when starting slow	640spm	40~9960	40spm
17	The speed of the fourth stitch when starting slow	1000spm	40~9960	40spm
18	The speed of the fifth stitch when starting slow	1680spm	40~9960	40spm
19	Limited maximum motor speed	4000rpm	20~5000	20rpm
20	Synchronizer sensor rotation sensing time	40 × 0.1sec	5~1275	0.5sec
21	Overload sensing time	30 × 0.1sec	5~1275	0.5sec
22	NOT USED	100ms	4~1020	4ms
23	Power off sensing time	4ms	4~1020	4ms
24	NOT USED			
25	Bad signal of the Encoder A and B phase detecting number of time	4	1~255	1
26	Back signal of the Encoder R, S and T phase detecting number of time	4	1~255	1
27	Bad signal of the Encoder R, S and T phase detecting number of time	4	1~255	1
28	NOT USED			
29	<ul style="list-style-type: none"> Automatic scaling to the speed curve selected by each set mode - Mode 0 : Use a curve based on the set values from C-1 to C-10 - Mode 1 : Scaling to the speed set at A-2 - Mode 2 : Scaling to the speed set using the Speed Up/Dn key 	1	1~2	1

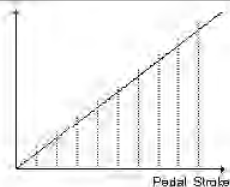

※ Items No. 1~5 : Equal division of pedal stroke in 64 steps, The speed curve of the pedal stroke changes according to how many steps are set up for the divided pedal stroke of each forward pedal step. (Used when adjusting pedal sensor)

※ No. 20 : If a synchronizer signal comes, but the next synchronizer signal does not come within the sensing time, an error message will appear .

※ No. 21 : If a speed instruction was sent to the motor but the motor does not reach the value of the speed instruction, an error message will appear.

[Caution]

If the specific items of the parameter are changed carelessly, they could break down or damage the machine, so the user must be well-trained before using it.

※ This item is operated by the factory only, so general users and A/S technicians should not use it.

No.	Function	Initial value	Step
30	OUTPUT00 (B/T Solenoid) : Low Active	0(Fixed)	※ Output port changing function - write the function number on the output PIN you want to change after referring to the table below
31	OUTPUT01 (P/F Solenoid) : Low Active	1(Fixed)	
32	OUTPUT02 (T/T Solenoid) : Low Active	2	
33	OUTPUT03 (W/P Solenoid) : Low Active	3	
34	OUTPUT04 (T/R Solenoid) : Low Active	4	
35	OUTPUT05 (Left Solenoid) : Low Active	5	
36	OUTPUT06 (Right Solenoid) : Low Active	6	
37	OUTPUT07 (AUX Solenoid) : Low Active	7	
38	OUTPUT10 (Left LED) : High Active	8	
39	OUTPUT11 (Right LED) : High Active	9	
40	OUTPUT12 (Needle upper stop notifying signal) : High Active	10	
41	OUTPUT13 (Needle lower stop notifying signal) : High Active	11	
42	OUTPUT14 (Signal notifying motor is running) : High Active	12	
43	OUTPUT15 (Signal notifying target has been reached) : High Active	13	

★ A : Output PIN function

Function No.	H/W type actual output name	Function No.	H/W type actual output name
0	B/T Solenoid (with duty)	100	inv. B/T Solenoid (with duty)
1	P/F Solenoid (with duty)	101	inv. P/F Solenoid (with duty)
2	T/T Solenoid (with duty)	102	inv. T/T Solenoid (with duty)
3	W/P Solenoid (with duty)	103	inv. W/P Solenoid (with duty)
4	T/R Solenoid (with duty)	104	inv. T/R Solenoid (with duty)
5	Left Solenoid (with duty)	105	inv. Left Solenoid (with duty)
6	Right Solenoid (with duty)	106	inv. Right Solenoid (with duty)
7	AUX Solenoid (with duty)	107	inv. AUX Solenoid (with duty)
8	Left LED (with duty)	108	inv. Left LED (with duty)
9	Right LED (with duty)	109	inv. Right LED (with duty)
10	"Needle Up-stop" notifying signal (with duty)	110	inv. Needle Up-Stopped (with duty)
11	"Needle Down-stop" notifying signal (with duty)	111	inv. Needle Down-Stopped (with duty)
12	"Sewing machine running" notifying signal (with duty)	112	inv. Motor Running (with duty)
13	"Target speed" notifying signal (with duty)	113	inv. Target Speed (with duty)
14	"Trimming" notifying signal (without duty)	114	inv. Trimming (without duty)
15	"End Back Tack" notifying signal (without duty)	115	inv. End Back Tack (without duty)
16	"Emergency stop" notifying signal (without duty) - A signal appears when the motor stops for any error.	116	inv. Emergency Stopped (without duty) -A signal appears when the motor stops for any error
17	Roller Lift Solenoid (without duty)	117	inv. Roller Lift Solenoid (without duty)
18	Hemming Device Output (without duty)	118	inv. Hemming Device Output (without duty)
19	"First step forward pedal" notifying signal (without duty)	119	inv. Pedal Start (without duty)
200	Low signal (without duty)	201	High signal (without duty)

※ If an output signal has been sent twice in the OUTPUT00~OUTPUT15 output pin, the same signal will appear in two different output pins.

Ex) if OUTPUT00 = 0 & OUTPUT03 = 0, then B/T signal is output from both OUTPUT00 & OUTPUT03 pin

※ When setting up other functions apart from the function numbers listed above, the pertinent output pin functions are disregarded.

※ Roller Lift Solenoid = Presser Foot-Lift solenoid + Back Tack solenoid + Roller Lift Switch

44~	NOT USED		
49	NOT USED		

[Caution]

If the specific items of the parameter are changed carelessly, they could break down or damage the machine, so the user must be well-trained before using it.



No.	Function	Initial value	Step
50	INPUT00 (Button A)	0	※ Output port changing function - Write the function number on the output PIN you want to change after referring to the table below
51	INPUT01 (Button B)	1	
52	INPUT02 (1/4 stitch Switch)	2	
53	INPUT03 (2/4 stitch Switch)	3	
54	INPUT04 (3/4 stitch Switch)	4	
55	INPUT05 (4/4 stitch Switch)	5	
56	INPUT06 (Left Sol. Switch)	6	
57	INPUT07 (Right Sol. Switch)	7	
58	INPUT10 (Presser Foot-Lift Switch)	8	
59	INPUT11 (Counter Switch)	9	
60	INPUT12 (P/U 1/2 stitch Switch Signal)	10	
61	INPUT13 (Safety Switch Signal)	11	
62	INPUT14 (Edge Sensor Signal)	12	
63	INPUT15 (Thread trimmer not allowed Signal)	13	
64	INPUT20 (Pedal Start Signal)	16	
65	INPUT21 (Pedal Presser Foot-Lift Signal)	17	
66	INPUT22 (Pedal Trim Signal)	18	

★ B : Input PIN function

No.	Actual Hardware Output Name	No.	Actual Hardware Output Name
0	Button A Switch	100	inv Button A Switch
1	Button B Switch	101	inv Button B Switch
2	1/4 stitch Switch	102	inv 1/4 stitch Switch
3	2/4 stitch Switch	103	inv 2/4 stitch Switch
4	3/4 stitch Switch	104	inv 3/4 stitch Switch
5	4/4 stitch Switch	105	inv 4/4 stitch Switch
6	Left Solenoid Switch	106	inv Left Solenoid Switch
7	Right Solenoid Switch	107	inv Right Solenoid Switch
8	Presser Foot-Lift Switch	108	inv Presser Foot-Lift Switch
9	Counter Switch	109	inv Counter Switch
10	Program Unit 1/2 stitch Switch	110	inv Program Unit 1/2 stitch Switch
11	Safety Switch	111	inv Safety Switch
12	Edge Sensor Signal	112	inv Edge Sensor Signal
13	Thread Trimmer Signal	113	inv Trimming Disabled Signal
14	Roller Lift Switch	114	inv Roller Lift Switch
15	N_AUTO Switch	115	inv N_AUTO Switch
16	Pedal Start Signal	116	inv Pedal Start Signal
17	Pedal Presser Foot-Lift Signal	117	inv Pedal Presser Foot-Lift Signal
18	Pedal Thread Trimming Signal	118	inv Pedal Thread Trimming Signal
19	External Signal	119	inv External Signal
20	Machine-Head-Open Switch	120	inv Machine-Head-Open Switch

※Caution : When any inputs PIN No. INPUT00 ~ INPUT22 are overlapped, it works as the "OR" circuit.

Ex) if INPUT00 = 0 & INPUT01 = 0, then it is recognized as "button A" = INPUT00 + INPUT01.

※ The hardware of input switches and sensors are done with "a point of contact/Active High" input as the standard.

※ When setting up other functions numbers apart from the ones listed above, the pertinent output pin functions are disregarded.

70	Output Signal Level Collective Reverse Function	0	0/1	1=Output signal Collective Reverse, selection
71	Input Signal Level Collective Reverse Function	0	0/1	1=Input signal Collective Reverse, selection
72-90	NOT USED			

[Caution]

If the specific items of the parameter are changed carelessly, they could break down or damage the machine, so the user must be well-trained before using it.

No.	Function	Initial value	Range	Step
91	Max. speed for height adjustable presser foot step 1 (permitted speed under height adjusting dial 2.5 or below)	3520	40 ~ 3520[spm]	40[spm]
92	Max. speed for height adjustable presser foot step 2 (permitted speed under height adjusting dial 2.5 to 3.0)	3000	40 ~ 3520[spm]	40[spm]
93	Max. speed for height adjustable presser foot step 3 (permitted speed under height adjusting dial 3.0 to 3.5)	2520	40 ~ 3520[spm]	40[spm]
94	Max. speed for height adjustable presser foot step 4 (permitted speed under height adjusting dial 3.5 to 4.0)	2000	40 ~ 3520[spm]	40[spm]
95	Max. speed for height adjustable presser foot step 5 (permitted speed under height adjusting dial 4.0 to 4.5)	1600	40 ~ 3520[spm]	40[spm]
96	Max. speed for height adjusting dial step 6 (permitted speed under height adjusting dial 4.5 to 5.0)	1200	40 ~ 3520[spm]	40[spm]
97	Max. speed for height adjusting dial step 7 (permitted speed under height adjusting dial 5.0 or above)	800	40 ~ 3520[spm]	40[spm]
99	NOT USED			

[Caution]

If the specific items of the parameter are changed carelessly, they could break down or damage the machine, so the user must be well-trained before using it.

(4) Group D Parameter: All types of gain parameter related motor control

- ※ These are functions not used by general users and must be regulated by an A/S technician.
- ※ The set value which listed below may show difference depends on motor.

No.	Function	Initial Value	Range	Step
1	speed P-gain Kvp	20	0~30	1
2	speed D-gain Kvd	20	0~300	1
3	location P-gain Kpp	170	0~500	1
4	location D-gain Kpd	2000	0~3000	1
5	acceleration A accelA	40	1~50	1
6	acceleration B accelB	70	1~50	1
7	acceleration C accelC	40	1~50	1
8	acceleration D accelD	8	1~50	1
9	sewing machine inertia value Inertia	40	0~255	1
10	positioning speed Wpos	220 rpm	100~500	2 rpm
11	stopping speed Wstop	75 rpm	0~500	2 rpm
12	Stop delaying time StopDelay	80 ms	4~1020	4 ms
13	Positioning distance DIST1	80 degree	0~255	1 degree
14	upper speed instruction unit spd_unit	100 spm	1~100	1 spm
15	Positioning P-gain Kpp2	400	0~500	1
16	Positioning D-gain Kpd2	4000	0~5000	1
17	Positioning P-gain Kpp3	100	0~500	1
18	Positioning D-gain Kpd3	1800	0~5000	1
19	NOT USED			
20	Overload rate limit function setting	0	0/1	
21	Pre-set overload rate	100[%]	0~255[%]	If the rated voltage of a motor is 100[%], it can be set by 1[%].
22	Pre-set overload rate limit time	Depending on the pre-set overload rate, the limit time is automatically calculated.	Parameter exit and re-entry should be conducted.	
23~	NOT USED			
99	NOT USED			

(5) Group F Parameter : TPM(Total Production Maintenance) related Parameters

No.	Function	Initial Value	Range	Step
1	TPM 1 Enable / Disable	0	0/1	0 : Disable 1 : Enable
2	TPM 2 Enable / Disable	0	0/1	0 : Disable 1 : Enable
3	TPM 3 Enable / Disable	0	0/1	0 : Disable 1 : Enable
4	TPM 4 Enable / Disable	0	0/1	0 : Disable 1 : Enable
5	TPM 5 Enable / Disable	0	0/1	0 : Disable 1 : Enable
6	TPM 6 Enable / Disable	0	0/1	0 : Disable 1 : Enable
7	TPM 7 Enable / Disable	0	0/1	0 : Disable 1 : Enable
8	TPM 8 Enable / Disable	0	0/1	0 : Disable 1 : Enable
9	TPM 9 Enable / Disable	0	0/1	0 : Disable 1 : Enable
10	Not Used			
11	TPM 1 time setting	750	1 ~9999	1[Hour]
12	TPM 2 time setting	1	1 ~9999	1[Hour]
13	TPM 3 time setting	1	1 ~9999	1[Hour]
14	TPM 4 time setting	1	1 ~9999	1[Hour]
15	TPM 5 time setting	1	1 ~9999	1[Hour]
16	TPM 6 time setting	1	1 ~9999	1[Hour]
17	TPM 7 time setting	1	1 ~9999	1[Hour]
18	TPM 8 time setting	1	1 ~9999	1[Hour]
19	TPM 9 time setting	1	1 ~9999	1[Hour]
20	Not Used			
21	Initialize the remain time when changing the TPM 1 set time.	1	0/1	0 : Disable 1 : Enable
22	Initialize the remain time when changing the TPM 2 set time.	1	0/1	0 : Disable 1 : Enable
23	Initialize the remain time when changing the TPM 3 set time.	1	0/1	0 : Disable 1 : Enable
24	Initialize the remain time when changing the TPM 4 set time.	1	0/1	0 : Disable 1 : Enable
25	Initialize the remain time when changing the TPM 5 set time.	1	0/1	0 : Disable 1 : Enable
26	Initialize the remain time when changing the TPM 6 set time.	1	0/1	0 : Disable 1 : Enable
27	Initialize the remain time when changing the TPM 7 set time.	1	0/1	0 : Disable 1 : Enable
28	Initialize the remain time when changing the TPM 8 set time.	1	0/1	0 : Disable 1 : Enable
29	Initialize the remain time when changing the TPM 9 set time.	1	0/1	0 : Disable 1 : Enable
30	Not Used			



Changing set values without thorough understanding of parameter details may lead to machine breakdown or physical damage. Users are recommended to have a full understanding of functions before use.

No.	Function	Initial Value	Range	Step
31	Set the TPM 1 password entry function	0	0/1	0 : Disable 1 : Enable
32	Set the TPM 2 password entry function	0	0/1	0 : Disable 1 : Enable
33	Set the TPM 3 password entry function	0	0/1	0 : Disable 1 : Enable
34	Set the TPM 4 password entry function	0	0/1	0 : Disable 1 : Enable
35	Set the TPM 5 password entry function	0	0/1	0 : Disable 1 : Enable
36	Set the TPM 6 password entry function	0	0/1	0 : Disable 1 : Enable
37	Set the TPM 7 password entry function	0	0/1	0 : Disable 1 : Enable
38	Set the TPM 8 password entry function	0	0/1	0 : Disable 1 : Enable
39	Set the TPM 9 password entry function	0	0/1	0 : Disable 1 : Enable
40	Not Used			
41	Enable the TPM function	1	0/1	0 : Disable 1 : Enable
42	Set the TPM password entry function	1	0/1	0 : Disable 1 : Enable
43	Machine rated speed	3600[spm]	40~5000[spm]	40[spm]
44	Environmental variable applied in the event of the set time reduction	20	0 ~ 20	1
45	Speed adjustment unit when adjusting time in line with current speed	400[spm]	400~2000[spm]	40[spm]
46	TPM test mode (900[Stitch]/1[Hour])	0	0/1	0 : Disable 1 : Enable
47	Not Used			
48	Not Used			
49	Not Used			
50	User password	0000	0000 ~ 9999	1

 Caution	<p>Changing set values without thorough understanding of parameter details may lead to machine breakdown or physical damage. Users are recommended to have a full understanding of functions before use.</p>
---	--



PARTS BOOK

NOTE : Parts are Subject to change in Design Without Prior Notice.

1. 조에 속한 파트는 개별 조립 시 제품의 파손 또는 재봉 불량 발생될 수 있어 해당 파트에 대한 주문 시에는 조 품목으로만 구입이 가능합니다.
 2. 본 책자는 Parts Book으로 제작되었으므로 매뉴얼로 사용 불가합니다.
- 1. The parts classified as ass'y items may cause damage to the machine or bad sewing when they are separately assembled. Hence, when they are ordered, they can be purchased as ass'y items only.**
 - 2. This is a parts book. It cannot be used as a manual.**

CONTENTS

A	Motor Mechanism - - - - -	137
B	Control Box Mechanism (Full Function Type) - -	139
C	Control Box Mechanism (Economic Type) - -	141
D	Control Box Mechanism (Full Function Type - 750W) - -	143
E	Program Unit Mechanism - - - - -	145
F	Small OP Parts - - - - -	147
G	Pedal Mechanism - - - - -	149
H	Synchronizer - - - - -	151

• Remarks •

Please let us get the additional details according to the itemized list below for the better service when ordering spare parts for SunStar motors.

※Order for spare parts for servo motor

- 1) Serial number
- 2) Type of control box & model name
- 3) Electric specification (Phase, Volt, Hz)
- 4) Machines' s model name

A

Motor Mechanism

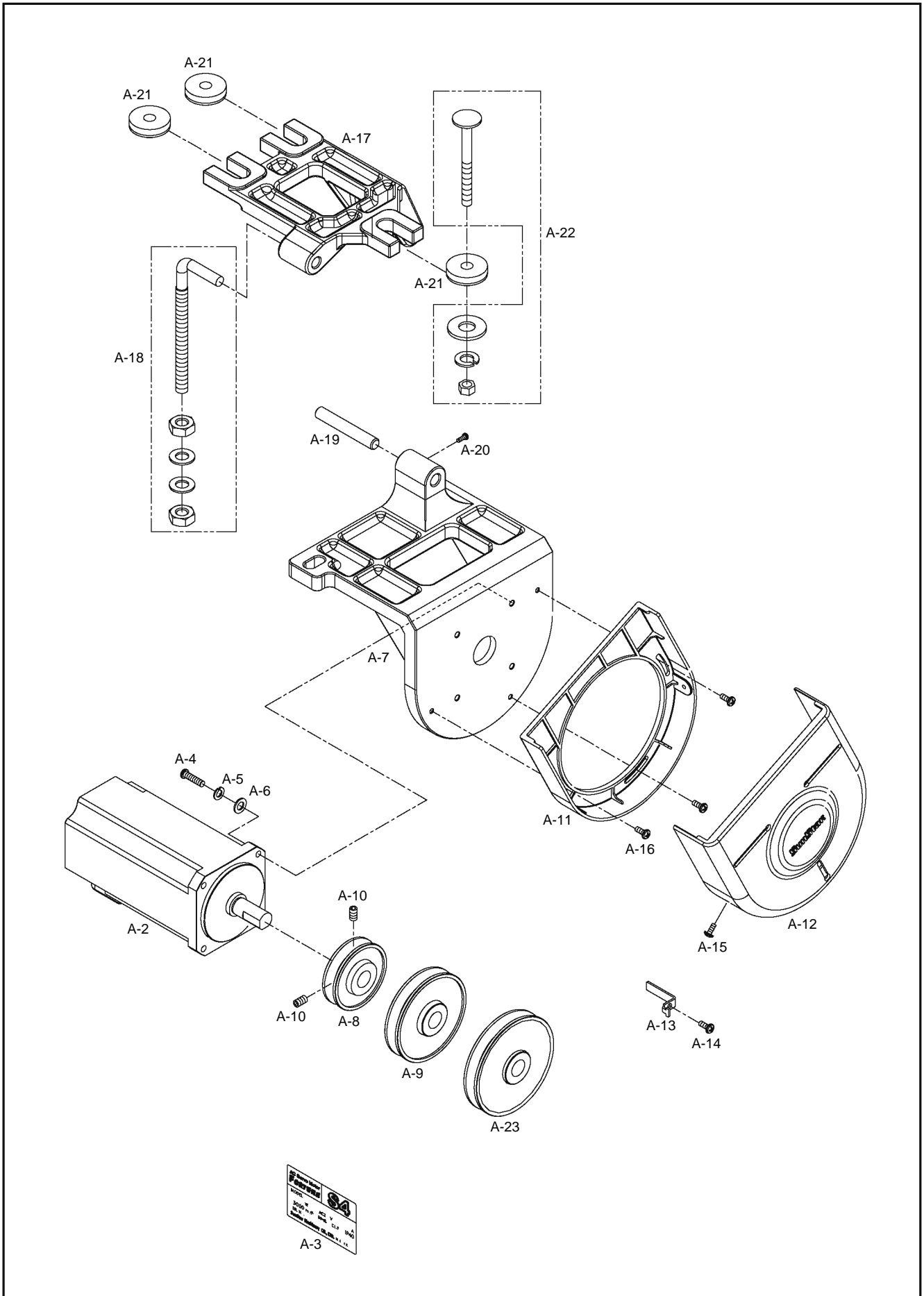

B

Control Box Mechanism (Full Function Type)

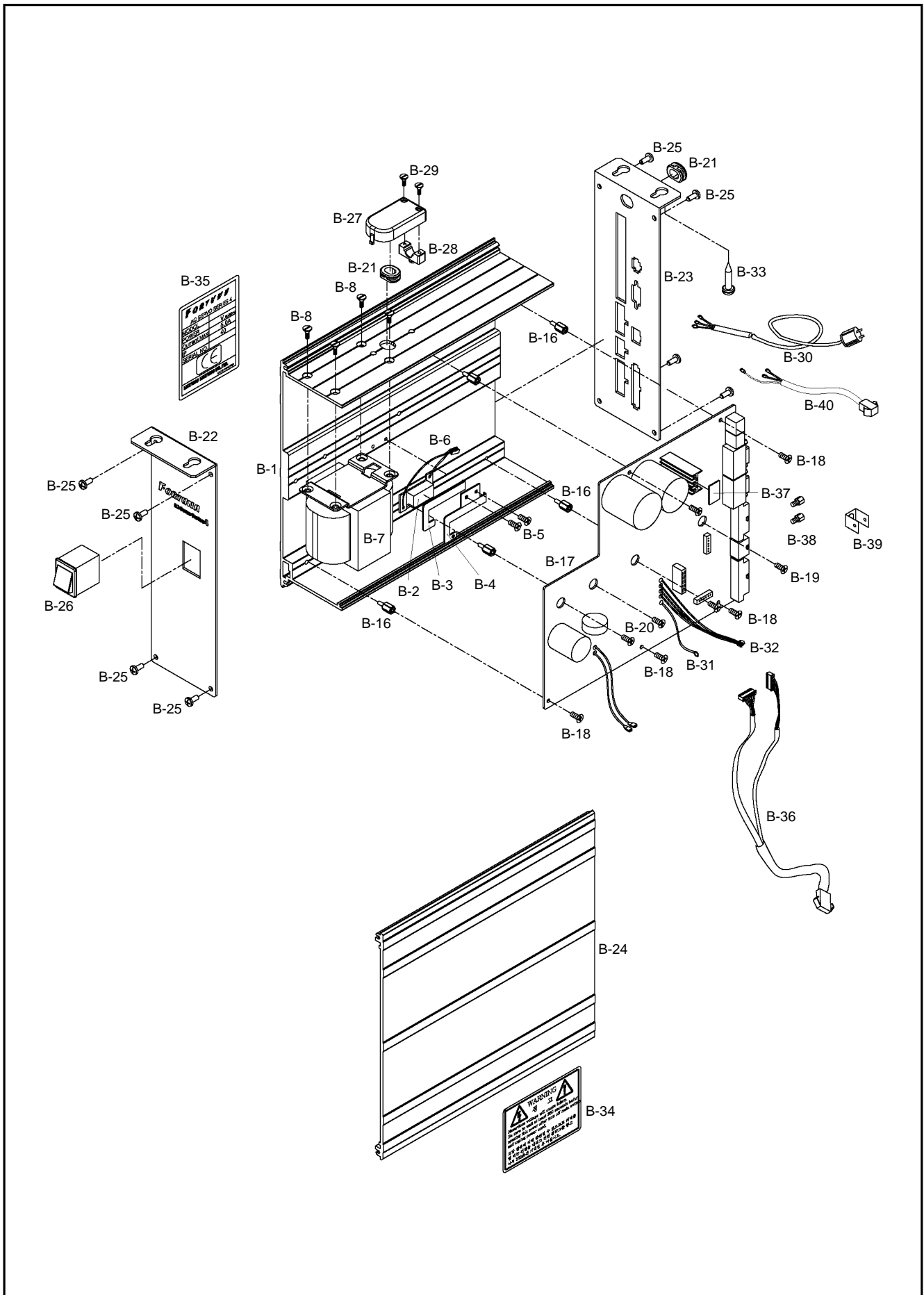



Control Box Mechanism (Economic Type)

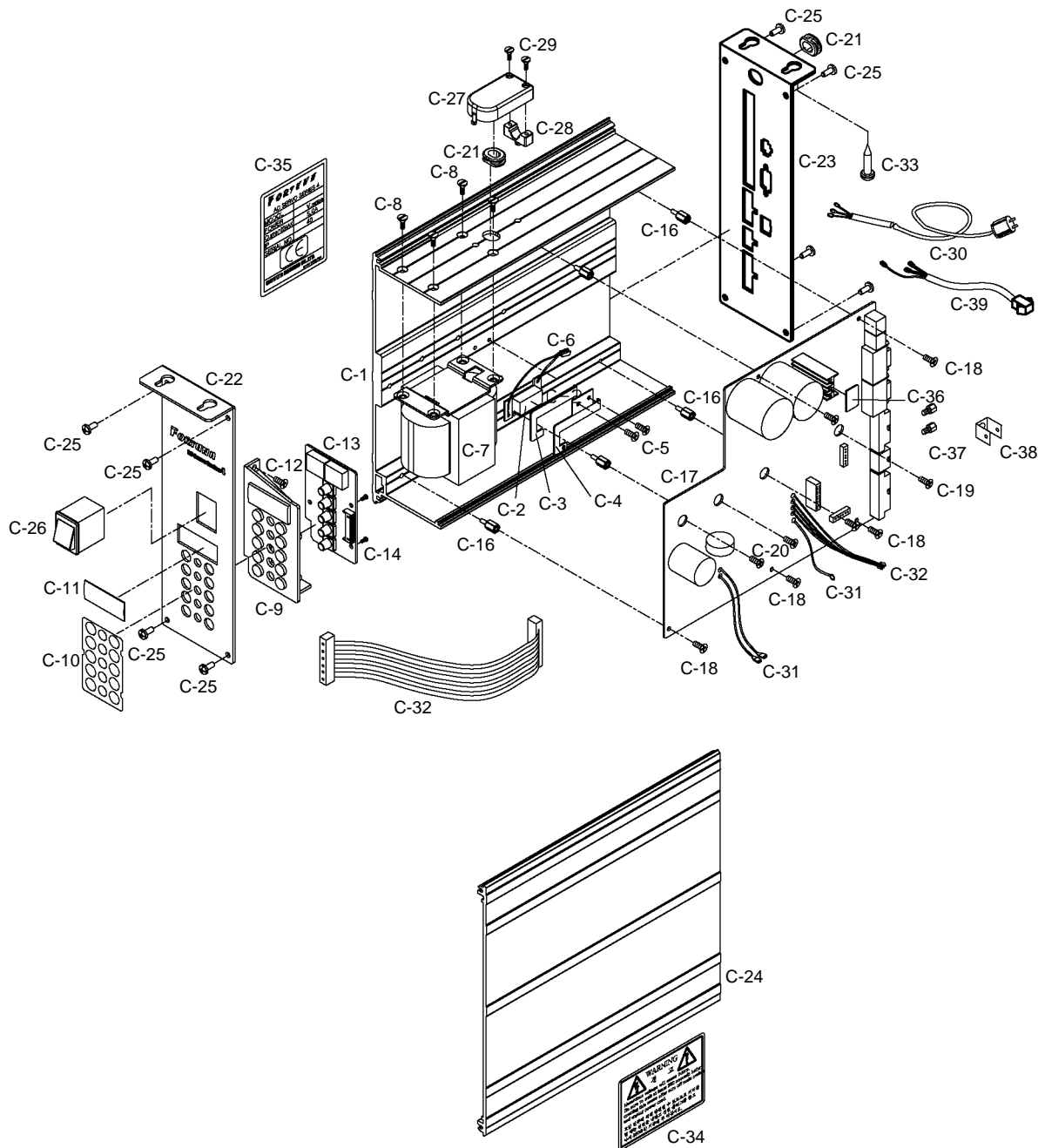

D

Control Box Mechanism (Full Function Type - 750W)

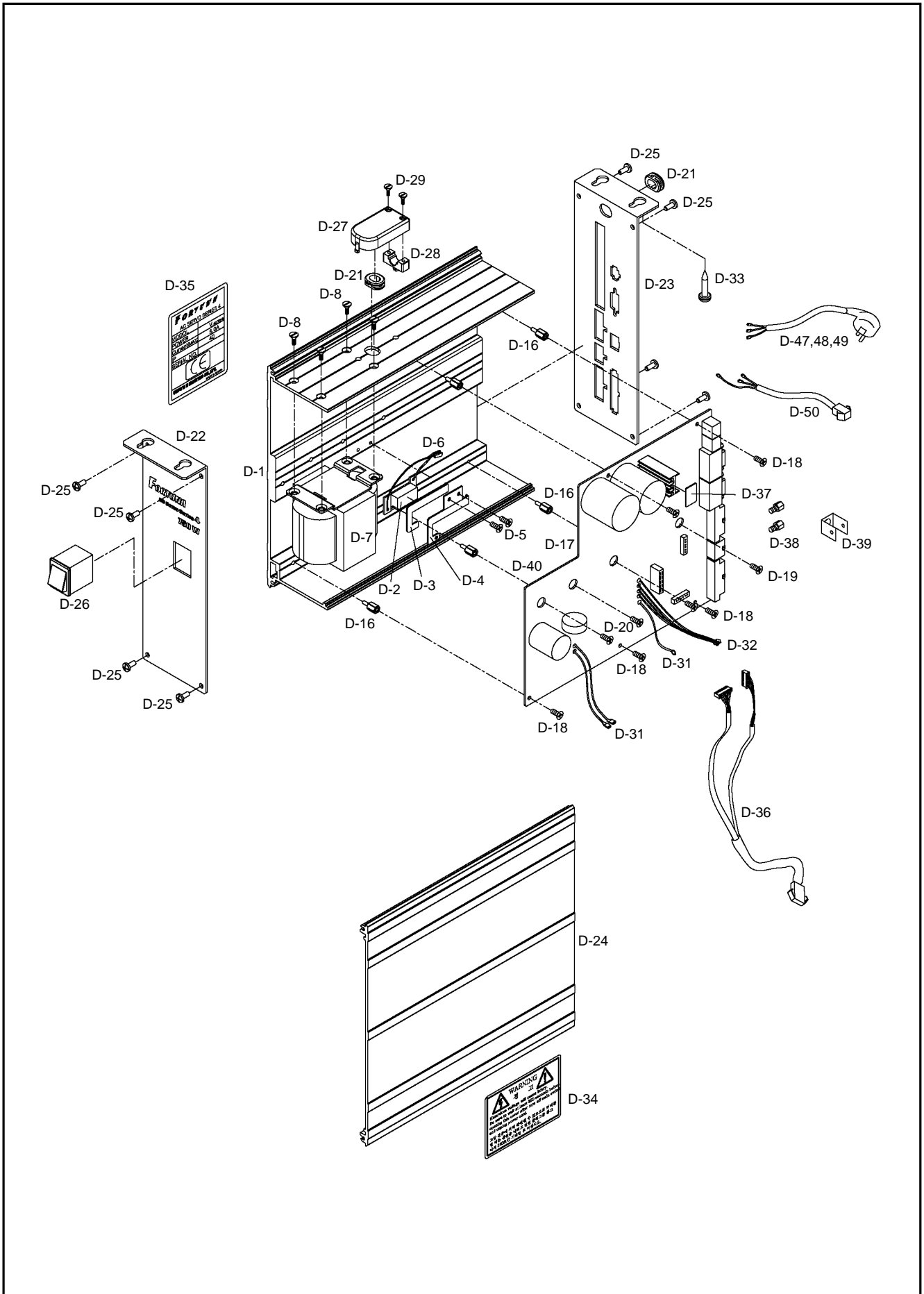

E

Program Unit Mechanism

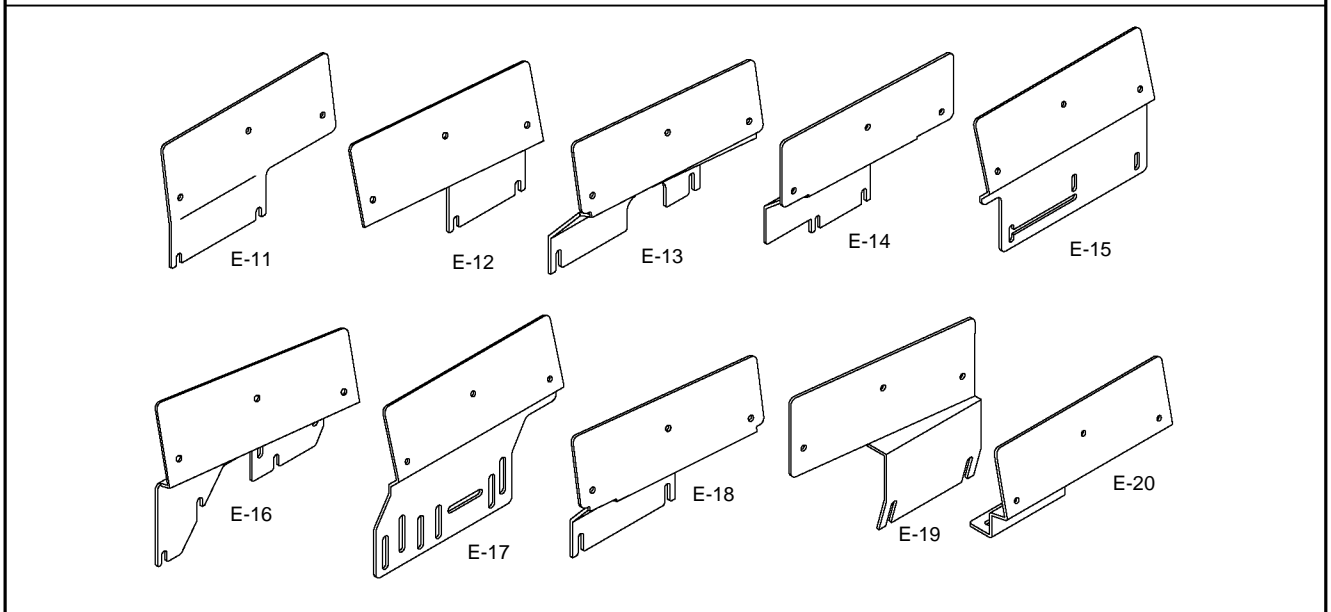
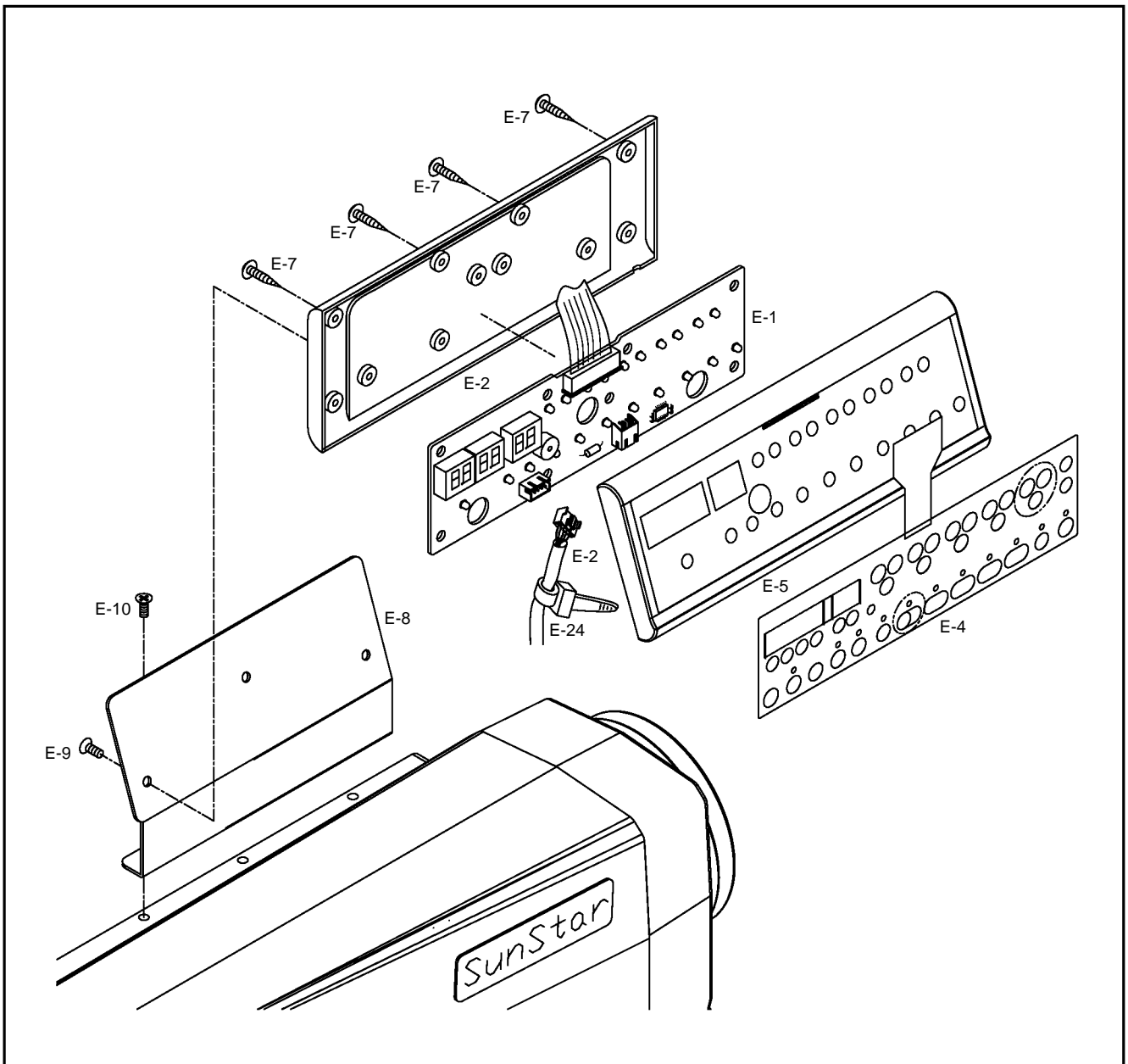

F

Small OP Parts

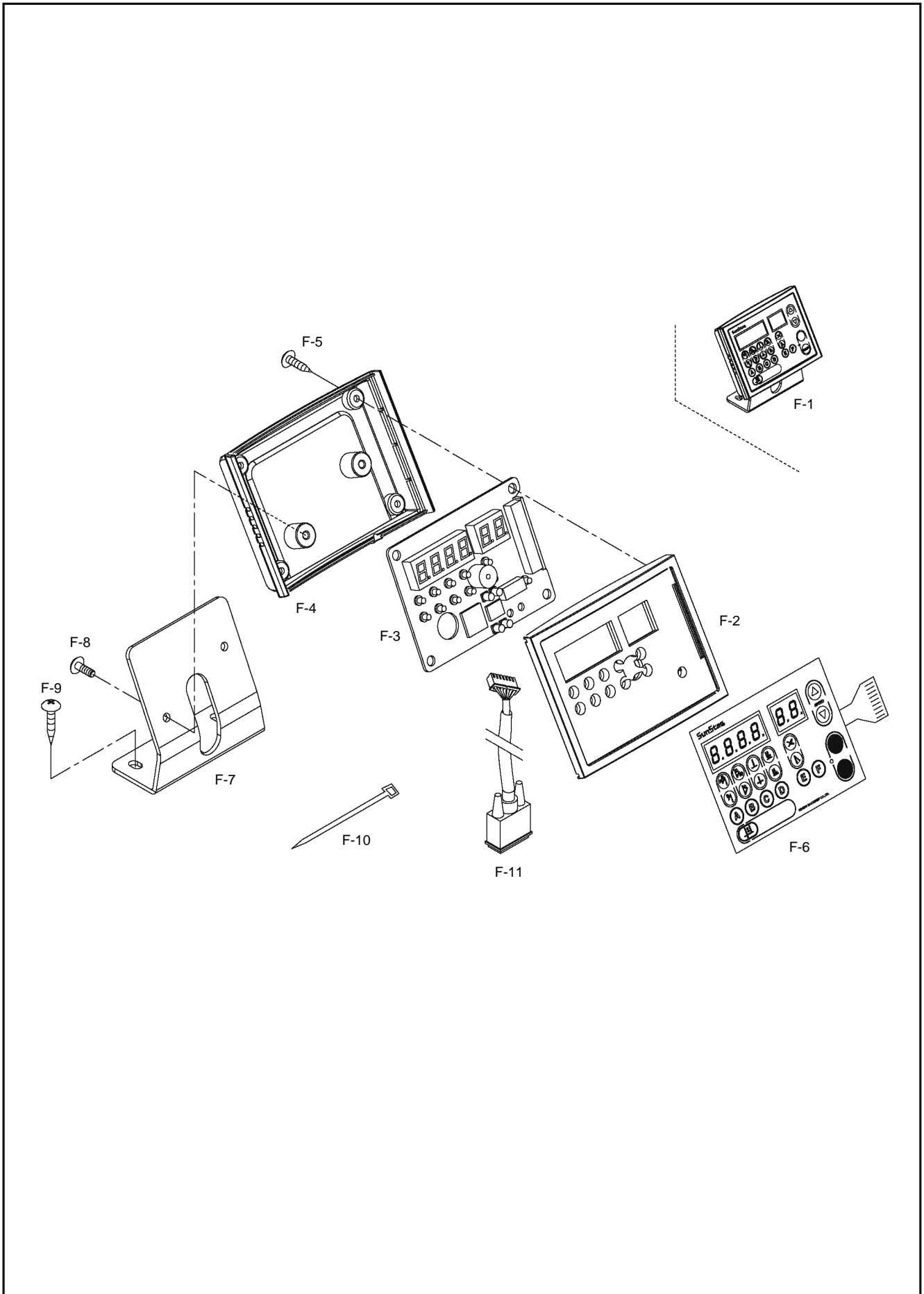



Pedal Mechanism

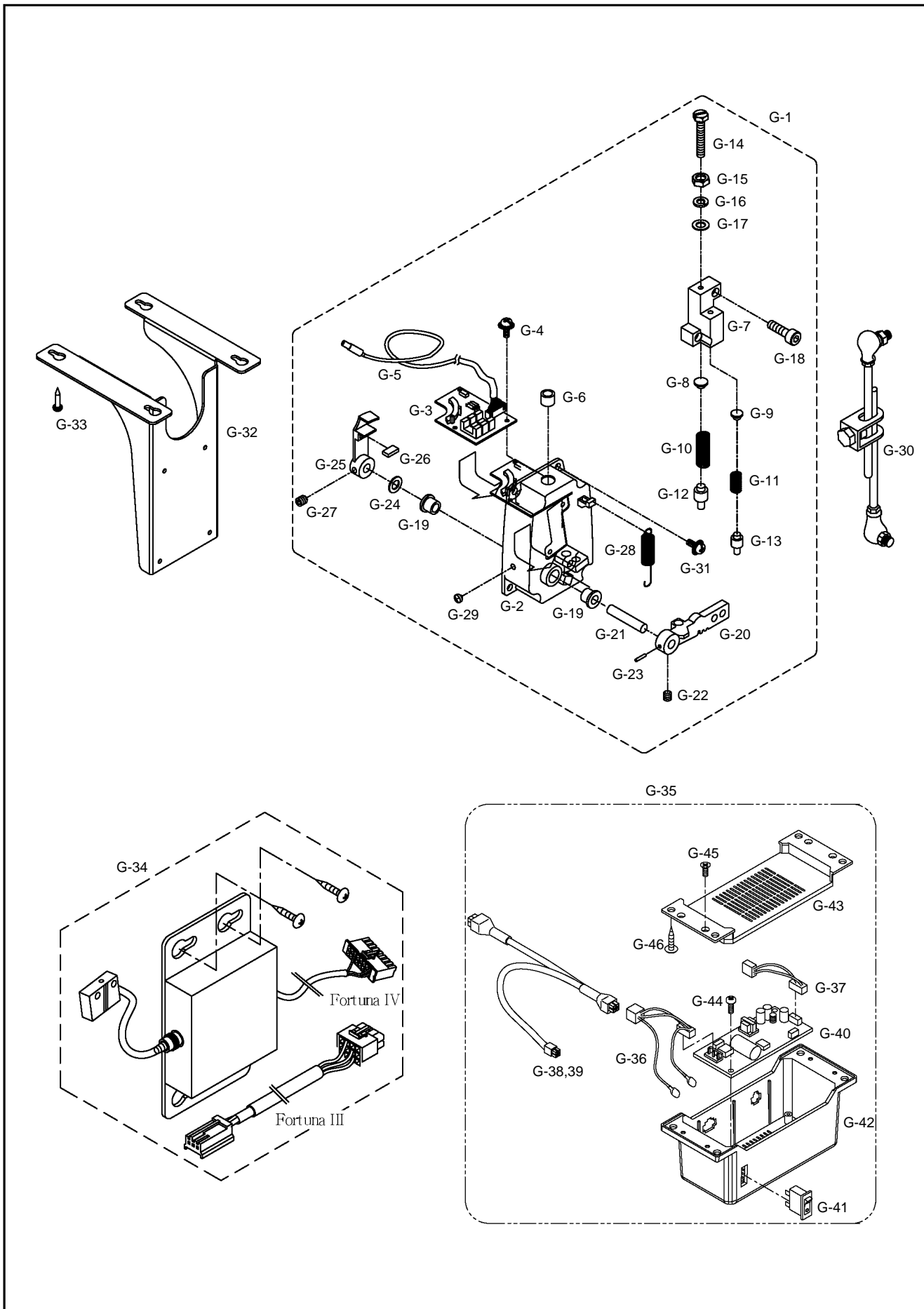



Ref. No.	Parts No.	Note	Name of Parts	품 명	Q' ty	Assembly No.
H-1	EA-000062-00		Synchronizer Ass'y	싱크로나이저(조)	1Set	
H-2	16-301A-9000		Synchronizer Base (KM-235)	싱크로나이저 베이스 (KM-235)	1	
H-3	16-302A-9000		Synchronizer Shaft (KM-235)	싱크로나이저 축 (KM-235)	1	
H-4	16-006B-SC53		Synchronizer Cover (KM-235)	싱크로나이저 커버 (KM-235)	1	
H-5	12-011S-SC53		Synchronizer Film (UP)	싱크로나이저 필름 (UP)	1	
H-6	12-012S-SC53		Synchronizer Film (DOWN)	싱크로나이저 필름 (DOWN)	1	
H-7	BD-000460-00		Synchronizer PCB (Ass'y)	싱크로 PCB (조)	1Set	
H-8	CA-001926-00		Synchronizer Cable	싱크로 케이블	1	
H-9	11-006C-SC53		Fixed Bushing For Synchronizer Film	싱크로 필름 고정붓싱	1	
H-10	11-007S-SC53		Screw For Synchronizer Film	싱크로 필름 고정나사	1	
H-11	11-008W-SC53		Washer For Synchronizer Film	싱크로 필름 고정와셔	3	
H-12	11-009S-SC53		Screw For Photo Sensor Assembly	포토 센서 (조) 고정나사	1	
H-13	11-024P-3701		Rdl Pin (3×16)	롤핀 (3×16)	1	
H-14	12-105B-SC53		P.C.B Holder	P.C.B 홀더	1	
H-15	08-015C-3701		Clip 4N	클립 4N	1	
H-16	16-008S-2000		Screw For Synchronizer Cover	싱크로 커버 고정나사	1	
H-17	16-010S-2000		Screw For Synchronizer Shaft	싱크로 축 고정나사	2	
H-18	09-042S-3701		Screw For Cable Holder	석면 지항 쥘나사	1	
H-19	16-007B-SC53		P.C.B Holder Plate	P.C.B 고정판	1	
H-20	EA-000063-00		Synchronizer Ass'y (Special Type)	싱크로나이저(조) (특종용)	1Set	
H-21	EA-000064-00		Synchronizer Ass'y (Other Company Type)	싱크로나이저(조) (타사용)	1Set	
H-22	15-026M-1000		Band Clip For Cable	케이블 타이 (4 inch)	1	
H-23	16-301A-SC51		Synchronizer Base (Special Type)	싱크로나이저 베이스 (560)	1	
H-24	16-303A-9000		Synchronizer Shaft (Special Type)	싱크로나이저 축 (560)	1	
H-25	16-008B-5600		Synchronizer Cover (560)	싱크로나이저 커버 (560)	1	
H-26	11-009S-SC53		Lock Screw For Photo Sensor Assembly	포토센서(조) 고정나사	1	
H-27	06-009B-SC53		Synchronizer Base (Other Company Type)	싱크로나이저 베이스 (타사용)	1	
H-28	06-303A-SC51		Synchronizer Shaft (Other Company Type)	싱크로나이저 축 (타사용)	1	
H-29	06-008B-SC53		Synchronizer Cover (Other Company Type)	싱크로나이저 커버 (타사용)	1	
H-30	12-105C-SC51		Lock Nut For Photo Sensor Assembly	포토센서 (조) 고정너트	1	
H-31	16-015A-2000		Bearing (6001z)	베어링 (6001z)	2	
H-32	12-102C-SC51		Stopper For Bearing	베어링 보호판	1	
H-33	12-103C-SC51		Stopper Bushing For Bearing	베어링 고정붓싱	1	
H-34	11-011C-SC53		Connection Bushing For Synchronizer (Other Company Type)	싱크로 연결 붓싱 (타사용) $\phi 15$	1	
H-35	11-012S-SC53		Screw (A) For E-34 (11/32" n=23)	싱크로 연결 붓싱 고정나사 (A)	1	
H-36	11-013S-SC53		Screw (B) For E-34 (5/16" n=24)	싱크로 연결 붓싱 고정나사 (B)	1	
H-37	11-104C-SC51		Connection Plate For Synchronizer	싱크로 연결판	1	
H-38	11-105C-SC51		Lock Rubber For Synchronizer	싱크로나이저 고정고무	1	
H-39	12-101C-SC51		Fixing Plate For Cable	케이블 고정판	1	
H-40	12-104C-SC51		Screw For E-39	케이블 고정판 고정나사	2	
H-41	16-010S-2000		Screw For E-34	싱크로나이저 축 고정나사	2	
H-42	12-103S-SC51		Screw For Photo Sensor Assembly (Other Company Type)	포토센서 (조) 쥘나사 (타사용)	1	
H-43	09-046W-3701		Spring Washer For Photo Sensor Assembly (Other Company Type)	스프링 와셔 (타사용)	1	
H-44	12-104C-SC51		Screw For Bearing Stopper	베어링 고정판 고정나사	3	
H-45	EA-000061-00		Synchronizer Ass'y (F-4 750W Internl Type)	싱크로나이저(조)/F-4 750W 내장형	1	
H-46	14-006A-4701		Synchronizer Cover	싱크로 커버	1	
H-47	11-021S-2500		Fix Screw for Synchronizer	싱크로 고정나사	2	
H-48	11-1022W-2500		Fix Screw for Washer	와셔	2	
H-49	BD-000459-00		Synchronizer PCB Ass'y	싱크로 PCB(조)	1Set	
H-50	CA-00192500		Synchronizer Cable	싱크로 케이블	1	